

# **Blastmate<sup>®</sup> II**

## **Operator Manual**



# Instantel® Inc.

<b>International / Canadian Customers:</b>	<b>U.S.A. Customers:</b>		
<b>Instantel Inc.</b> 309 Legget Drive Ottawa, Ontario K2K 3A3 Canada	<b>Instantel Inc.</b> 808 Commerce Park Drive Ogdensburg, NY 13669 U.S.A.	<b>Telephone:</b>	1-613-592-4642
		<b>Toll free:</b>	1-800-267-9111
		<b>Facsimile:</b>	1-613-592-4296
		<b>Website:</b>	www.instantel.com

## Customer Support:

**Instantel** is represented by a network of qualified dealers throughout the United States, Canada, and Internationally. For further information, including product literature and the location of the dealer nearest you, contact **Instantel**.

- Extensive dealer network.
- Comprehensive application support.
- In-depth user documentation.
- Technical support, 1-613-592-4642 or e-mail [service@instantel.com](mailto:service@instantel.com)

## Warranty:

All **Instantel** products come with a one-year warranty. Series III monitors (**Blastmate® III**, **Minimate™ Blaster**, and **Minimate Plus™**) and sensors will have the warranty extended for a second year if they are returned to the **Instantel** factory for service and calibration within 30 days of the 'Next Calibration' date printed on the calibration label located on the product.

If within a period of one year from the date of shipment to a customer the instrument fails to perform in accordance with Instantel's published specifications and the operator's manual, due to a defect in materials or workmanship, it will be repaired or replaced at **Instantel's** option, free of charge. This warranty is void if the equipment has been dismantled, altered or abused in any way. This warranty is nontransferable.

The above warranty does not include any implied warranty of functionality for a particular purpose. **Instantel** assumes no responsibility for damages of any description resulting from the operation or use of its products. Since it is impossible to anticipate all of the conditions under which its products will be used either by themselves or in conjunction with other products, **Instantel** cannot accept responsibility for the results unless it has entered into a contract for services which clearly define such an extension of responsibility and liability.

Any shipments returned directly to Instantel Inc. must have our prior approval and all packages must display the Return of Material Authorization (RMA) Number issued by Instantel. Shipping charges to **Instantel's** plant will be paid by the customer and those for return to the customer will be paid by Instantel.

To protect your warranty, you must complete and return a Warranty Registration Certificate, or complete the online Warranty Registration Form, within ten days of purchase. Units will be assumed out of warranty if there is no warranty card on file at Instantel. Retain this portion and the proof of purchase for your records.

## Warning:

This is an electronic instrument. Although it has been designed for field use, it contains sensitive components which cannot be expected to withstand the same stress and shock as heavy machinery. It contains a microcomputer and solid state memory, both of which may be made inoperative by severe radio interference. The use of transmitting equipment in the immediate vicinity of the unit should be avoided. Evidence of negligence in the care or handling of the instrument may void the manufacturer's warranty. This product contains no serviceable parts. The battery is not intended to be replaced by the operator. The unit should be returned to an authorized Instantel service center for service. Any attempt to service this product will void any and all warranties offered by Instantel. Service enquiries should be made via your dealer.

## CE EC Warning:

This is a Class A product. In a domestic environment this product may cause radio interference in which case the user may be required to take adequate measures.

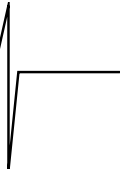

---

# Table of Contents

<b>Before You Begin</b> .....	<b>v</b>
Check the Package Contents.....	v
Record the BlastMate III Identification Numbers.....	v
Check Your Local Electric Power Supply.....	v
Charge the Battery.....	vi
Check the Monitor's Memory.....	vi
Complete and Return Your Registration Card.....	vi
Handling Precautions.....	vi
Condensed Instructions.....	viii
Conventions Used throughout this Manual.....	viii
<b>1. Introduction</b> .....	<b>1-1</b>
1.1. BlastMate III Models.....	1-1
1.2. Features and Benefits.....	1-2
1.3. Accessories.....	1-3
1.4. The BlastMate III Keys.....	1-4
<b>2. Basic Tutorial</b> .....	<b>2-1</b>
<b>3. Compliance Module</b> .....	<b>3-7</b>
3.1. What is Event Monitoring?.....	3-7
3.2. Eight Channel Models.....	3-8
3.3. Installing the Standard Transducer.....	3-8
3.3.1. Soft Surface Installations.....	3-8
3.3.2. Hard Surface Installations.....	3-10
3.4. Installing a Microphone.....	3-10
3.5. The BlastMate III Keyboard.....	3-11
3.6. Run Keys.....	3-11
3.6.1. On/Off Key.....	3-11
3.6.2. Review Setups Key (Compliance Module Only).....	3-11
3.6.3. Test Key (Compliance Module Only).....	3-11
3.6.4. Start Monitor Key.....	3-12
3.7. Program Keys.....	3-12
3.7.1. Record Mode Key.....	3-12
3.7.2. Record Time Key.....	3-14
3.7.3. Trigger Source Key.....	3-16
3.7.4. Trigger Level Key.....	3-16
3.7.5. Setups Printer Key.....	3-16
3.7.6. Setups Special Key.....	3-18
3.7.7. Option Key.....	3-23
3.7.8. Option Key + Special Key.....	3-23
3.7.9. Option Key + Time/Day Key.....	3-25
3.7.10. Notes Key.....	3-26
3.7.11. Time/Day Key.....	3-26



3.8. Edit Keys.....	3-27
3.8.1. Enter * Key .....	3-27
3.8.2. Help Key .....	3-27
3.8.3. Cancel Key.....	3-28
3.8.4. Arrow Keys .....	3-28
3.9. Events Keys .....	3-28
3.9.1. List/Delete Key .....	3-28
3.9.2. Print Key .....	3-29
3.10. Printer Keys .....	3-32
3.10.1. Paper Feed Key .....	3-32
3.10.2. Paper Takeup Key .....	3-32
3.11. Back Light Key .....	3-32
3.12. Keyboard Keys.....	3-32
<b>4. Advanced Module.....</b>	<b>4-1</b>
4.1. Option Key + Special Key .....	4-1
4.1.1. Instrument Mode .....	4-1
4.2. Test Key.....	4-1
4.3. Record Mode Key .....	4-2
4.3.1. Sample Rate .....	4-2
4.3.2. Channel Range .....	4-2
4.4. Record Time Key .....	4-2
4.5. Trigger Source Key.....	4-3
4.6. Trigger Level Key.....	4-3
4.7. Setups Special Key.....	4-4
4.7.1. Advanced Channels.....	4-4
<b>5. Reference .....</b>	<b>5-1</b>
5.1. Additional Installation Procedures .....	5-1
5.1.1. Wall Installation.....	<b>Error! Bookmark not defined.</b>
5.1.2. Ceiling Installation.....	<b>Error! Bookmark not defined.</b>
5.2. Theory of Operation.....	5-3
5.2.1. Transducer.....	5-3
5.2.2. Microphone .....	5-4
5.3. Sensorcheck .....	5-5
5.3.1. Checking the Transducer's Geophones .....	5-5
5.3.2. Checking the Microphone .....	5-6
5.3.3. Sensorcheck Report.....	5-6
5.4. Anti-alias Filters.....	5-6
5.5. Data Analysis Techniques.....	5-6
5.5.1. Ground Vibrations.....	5-6
5.5.2. Sound Pressure .....	5-9
5.6. Alternate Manual Waveform Calculations.....	5-10
5.6.1. Sinusoidal Waveforms .....	5-10
5.6.2. Nearly Triangular Waveforms.....	5-11
5.6.3. Compound Waveforms .....	5-11
5.6.4. Irregular Waveforms .....	5-12

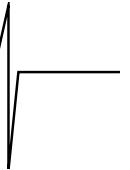

<b>6. Maintenance .....</b>	<b>6-1</b>
6.1. Battery Charging.....	6-1
6.2. Annual Calibration Requirements.....	6-2
6.3. Cleaning the BlastMate III.....	6-2
6.4. Loading Paper into the Printer .....	6-2
6.5. Printer Handling Precautions .....	6-3
6.5.1. Printer .....	6-3
6.5.2. Head Cleaning Procedure.....	6-4
6.6. Paper Handling Precautions.....	6-4
<b>7. Troubleshooting .....</b>	<b>7-1</b>
<b>Appendix .....</b>	<b>A-1</b>
a) Parts and Accessories .....	A-3
b) Series III Specifications.....	A-4
c) Compliance Reports.....	A-5
d) Calculating Battery Life .....	A-6
<b>Index .....</b>	<b>I-1</b>

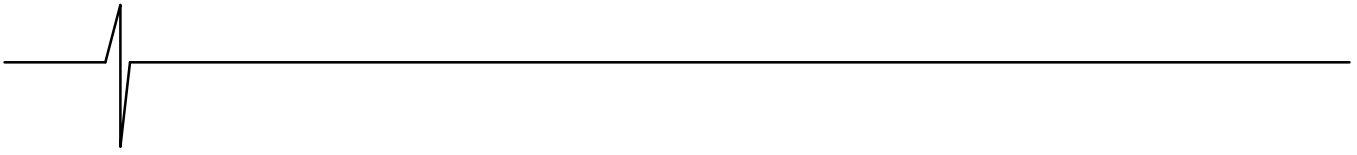

**Notes:**

---



## Thank You . . .

*Thank you for purchasing Instantel's BlastMate Series III. You will find it the most advanced and easy-to-use seismograph available. If this is your first Instantel seismograph, welcome to the new World Standard set by Instantel. If this seismograph adds to your existing fleet, congratulations! You will find the new features simple to use and offer you powerful control over your monitoring operations.*

---

## Before You Begin

Before you begin using your new BlastMate III, please complete the following. It only takes a few minutes of your time and ensures your monitor is ready for operation and that you become part of Instantel's Product Support Program.

Important information appears within the BlastWare III software Readme file. Install the BlastWare III software then read this file for additional information. See the BlastWare III Operator Manual for installation instructions.

## Check the Package Contents

Please check that you received all the parts identified on your shipping invoice. Remember to keep your shipping box because it was designed to safely ship your monitor. It is an important component of what you have just purchased.

## Record the BlastMate III Identification Numbers

Record the following identification numbers for future reference.

IDENTIFICATION NUMBERS	
Model Number	
Monitor Serial Number	
Monitor Software Version Number	
Standard Transducer Serial Number (If applicable)	
Microphone Serial Number	
Dealer Name	
Date Purchased	

## Check Your Local Electric Power Supply

Every BlastMate III comes with a 120 VAC 60 Hz input AC adapter providing 10 to 14 VDC, 500 mA output. An optional 220 VAC adapter is available. Check with your local power utility to ensure the supplied electric power may be used with the BlastMate III. Your dealer may have already supplied an optional AC adapter. If not, contact your dealer and ask about the optional AC Adapter.

**Note to Our Customers in India and Other Countries**



Due to large power fluctuations found in countries including India, please use a voltage stabilizer and a 220 V AC Adapter to provide 10 - 14 VDC @ 500 mA to power the monitor.

## Charge the Battery

Before you use the BlastMate III, charge its battery for at least 24 hours. Although InstanTel ships every BlastMate III fully charged, it is a good idea to top up the battery's charge before use. Install the 5 amp/250 Volt fast blow fuse part number F5AF250V. To check the battery charge, turn the BlastMate III on and read the battery level displayed in the Main Window.

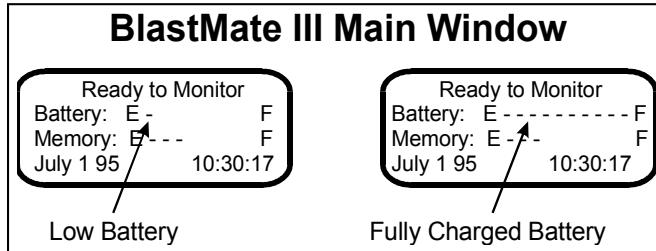

Figure 1 Battery Level Indicator.

To charge the battery, plug the AC adapter into the PWR connector located at the front of the BlastMate III. Plug the other end into a 120 VAC 60 Hz electrical outlet. The charging light located under the carrying handle indicates the battery is being charged.

**WARNING:** Open the monitor's lid to ensure adequate battery ventilation during charging. Always charge in a well ventilated area.

Do not allow the battery to become discharged and left in a discharged state for any extended period of time. Allowing the battery to become discharged may cause permanent damage to the battery.

You can operate the BlastMate III while it is being charged. Try the Basic Tutorial, Chapter 2, for a quick and easy lesson on how to record events.

## Check the Monitor's Memory

The Main Window also displays the amount of memory available. The bar line has ten bars with each representing ten percent of the total internal memory. When the memory is empty, you can record events. When the memory is full, the memory has stored the maximum number of events and cannot store more events until you delete the stored events.

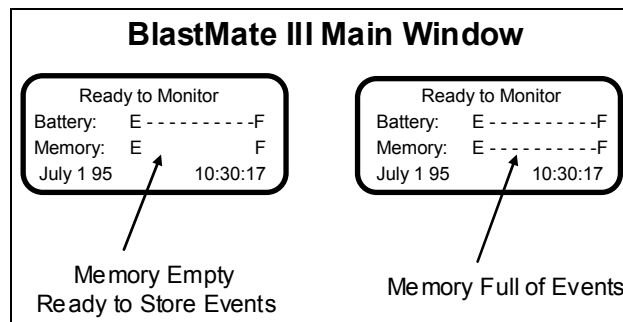



Figure 2 Memory Available Indicator.

## Complete and Return Your Registration Card

InstanTel offers the most comprehensive Product Support Program available. You receive a two year warranty, product support, and product updates (your monitor and sensors must be returned



---



to InstanTel for annual calibration and servicing to maintain your warranty). You also receive free software upgrades for the BlastMate III and the BlastWare III software programs for the first year. All you have to do is complete the registration card included with your BlastMate III and return it to InstanTel by mail or facsimile within thirty (30) days of purchasing your new monitor.

## Handling Precautions

- **Handle All Components with Care.**
- **Keep the BlastMate III On Charge.**

Leaving the BlastMate III in a totally discharged state for an extended period of time irreparably damages the battery. Always charge the battery when fewer than two graph bars appear in the display or immediately when the BlastMate III beeps. A message appears on the display telling you to charge the monitor. When not in use, keep the BlastMate III on charge. InstanTel's charger, supplied, protects the battery from overcharging.
- **Remove the Fuse if Storing the BlastMate III.**

If storing the BlastMate III for prolonged periods of time, always remove the fuse to extend battery life. Recharge the battery every six months for twenty four hours.
- **Always Hold a Cable by its Connector.**

Do not hold the cord to pull on a connector when connecting or disconnecting it.
- **Never Force a Connector.**

Always align the connector to the port before inserting.
- **Do Not Touch the Printer or its Motor During or Immediately After Printing.**

The printer platter and motor may become hot during printing.
- **Use Only the InstanTel Cable Supplied to Connect the BlastMate III to a Personal Computer.**

Use the BlastMate III PC connecting cable only, part number 712A2301. Using other cables including the BlastMate II to MiniMate™ connecting cable, part number 715A0501, may damage your unit.
- **Never Connect or Disconnect Cables Without First Turning Off the BlastMate III and Your Computer.**
- **Do Not Drop the BlastMate III or Submerge it in Liquids.**

The BlastMate III is rugged and designed to withstand normal wear and tear. The BlastMate III is splash resistant designed to withstand temporary exposure to drops of water. It is not waterproof and should not be immersed in water. Immersing the monitor or installing the monitor where standing water may accumulate may damage the monitor.
- **Keep Computer Disks Away from all Transducers.**

The geophones inside the transducers contain magnets that could erase the data stored on computer disks.
- **Clean the BlastMate III Periodically.**

Vacuum dust, dirt, and sand from the BlastMate III. Use alcohol to remove stains. Do not use paint thinners and ketone solvents. These may damage the BlastMate III. To avoid scratching the protective cover and display, do not scrub the surfaces with abrasive material including cleaning pads.

---

## Condensed Instructions

1. Set and level sensors and connect cables.
2. Turn unit on by depressing the **ON/OFF** key.
3. Watch messages for battery and unit status, correct time and date.
4. You may verify setups by pressing **Review setups** .
5. Press **Start Monitor** to enter MONITOR mode.
6. Depending on setup, the unit performs a sensor test and "Performing Sensorcheck" is displayed on the LCD. Do not touch the sensors while this message is shown.
7. If accidentally triggered before a blast, press **CANCEL** and when the message "Ready to monitor" appears go back to step 5.
8. When finished, turn off unit. Disconnect and stow cables and sensors.

**IMPORTANT: KEEP UNIT ON CHARGE WHEN NOT IN USE TO AVOID BATTERY DAMAGE**

## Conventions Used throughout this Manual

The following typographical conventions appear throughout this manual.

- Bold type** This type tells you which BlastMate III keys to press. For example, when you see **Start Monitor** key, it means press the **Start Monitor** key located on the BlastMate III keyboard.
- Window** This word, when capitalized, refers to a message window appearing on the BlastMate III display. For example, when you see Main Window, it refers to the following display:

```
Ready to Monitor
Battery:  E -----F
Memory:  E -----F
July 1 95      10:30:17
```

# 1. INTRODUCTION

The BlastMate Series III offers the most advanced monitoring technology available, with unequalled versatility and flexibility to meet current needs and future requirements. As a smart device, your BlastMate can be programmed for new features as they are released by InstanTel through BlastWare III, the software companion to your monitor.

The BlastMate III operates as a basic compliance monitor with intuitive functions and ease-of-use to help the first time operator setup and record an event quickly. The BlastMate III also offers advanced functions for specific applications where more information is collected and analyzed.

This manual is divided into sections. The first section is a tutorial for the new user. Follow this tutorial to record your first event quickly and easily. This section describes basic functions with illustrative examples to lead you through. The following section, called the Compliance Module, covers the operation of the monitor for the compliance user. The next section, the Advanced Module, explains the operation of the monitor using the optional advanced module software. The last sections provide reference and maintenance information, extensive troubleshooting support, followed by supporting information in the Appendix.

## 1.1. BlastMate III Models

The BlastMate Series III monitors include two models based on the number of recording channels. The standard model offers four recording channels with an external standard transducer and microphone. The second model offers eight recording channels with your choice of external transducers and microphones. All models offer the level of performance and ease-of-use you expect from InstanTel monitors.



Figure 1.1 The BlastMate III Standard Model.

## 1.2. Features and Benefits

The BlastMate III offers outstanding features unequaled in the industry. The following table lists some of the features. Please see the specifications located in the Appendix of this manual for a complete list.

- **Two Year Warranty** – full two year no nonsense parts and labor warranty on the monitor. A calibration and equipment check at the one year mark is required to ensure continued reliable performance.
- **300 Full Waveform Event Capacity** – 300 event capacity standard, 1500 optional, for one second 4 channel events at 1024 samples per second.
- **High Resolution Fast Printer.**
- **Personal Operation** – complete ability for you to customize how the monitor operates. Anything you do not need can be hidden and does not get in the way, yet is immediately available when you need it.
- **Large Backlit Display** – no doubts about what the monitor is doing or what you have to do.
- **Multiple Record Modes** – offer you unlimited flexibility during monitoring operations: single event, continuous, auto record, programmed start/stop, and manual.
- **Full Waveform Event Analysis** – full field analysis of the event including peak particle velocity (PPV), peak air(sound) pressure, peak vector sum (PVS), peak acceleration, and peak displacement.
- **National Frequency Analysis Standards** – many national frequency analysis standards come with the BlastMate III. Future standards can be programmed into the monitor as they are implemented, with no additional cost or equipment change required, using BlastWare III software. Standards include U.S.A. USBM/OSMRE, British Standard BS 6472, French GFEE, German DIN 4150, New Zealand 4403:1976, and Spain UNE 22.381. Contact InstanTEL for further information.
- **Full PC Compatibility** – to archive, print, and perform analysis and process capabilities with BlastWare III software modules.
- **Variable Sample Rates** – 1024 and 2048 standard for unprecedented compliance accuracy or high frequency blast performance analysis. Higher sample rates to 65,536 available with the BlastWare III Advanced Module software. Contact InstanTEL for further information.
- **On-line Help** – informative, context sensitive help guides you through all operations.
- **Upgradable** – neither you nor InstanTEL can predict the future, so we have designed your BlastMate III to be easily and economically upgraded.
- **Rugged Design** – Series III exceeds the field test for rugged, durable design with a fully sealed top panel, non-corrosive industrial grade connectors, and sealed electronics, all packed in a single rugged case. InstanTEL monitors have been buried; rolled off trucks; thrown down mine drifts by air blast; hit with flyrock; run over by backhoes; and have survived in working order.

## 1.3. Accessories

Instantel's complete line of BlastMate III accessories offer you the control and flexibility to monitor all types of events.

- **Extra Event Memory** – 300 event capacity standard and 1500 optional, for one second 4 channel events at 1024 samples per second.
- **External Standard Transducer** – 2 to 300 Hz frequency response.
- **High Frequency Uniaxial Geophone** – for high frequency recording.
- **4.5 Hertz Uniaxial Geophone** – horizontal and vertical models.
- **Low Level Triaxial Geophone** – measures low level vibrations. Two models are offered with the following ranges: 2.54 mm/sec (0.1 in/sec), and 25.4 mm/sec (1 in/sec).
- **High Frequency Accelerometer**
- **Hydrophone Sensor** – underwater sensor with 200 ft. (60 m) cable.
- **VOD Module** – records velocity of detonation of an explosive to assess blasting efficiency.
- **Cable Line Driver** – provide long distance monitoring using Series III extension cables.
- **Transducer Leveling Plate** – with adjustable leveling feet and integrated bubble level. Used to mount the standard transducer to a wall or ceiling as well as ground installations.
- **Two Microphone Types** – Linear “L” or “A” Weight – Linear “L” for air pressure measurement affecting structures and “A” Weight for human response.
- **High Pressure Microphone** – measures air pressure up to 5.0 psi (34.5 kPa).
- **Remote Alarm** – self contained remote alarm indicator complete with high power auxiliary drive capability for external sirens and other alarms.
- **DS 20 Wire Trigger** – a wire, broken by an explosion, transmits a signal to trigger the BlastMate III to start recording.
- **120 VAC and 220 VAC Adapter** – connect the BlastMate III to your local electrical power supply.
- **Auto / 12 V Adapter** – connect the BlastMate III to your vehicle's 12 volt power supply or a 12 volt battery for remote installations.
- **Extension Cable** – general purpose extension cable to connect transducers, microphones, and a personal computer. Available in standard and custom lengths.
- **Null Modem Cable** – for modem communication between the monitor and a modem.
- **Accessory Case** – carry BlastMate III accessories in a hard case, similar to the BlastMate Series III case. Removable foam accommodates your accessories.

## 1.4. The BlastMate III Keys

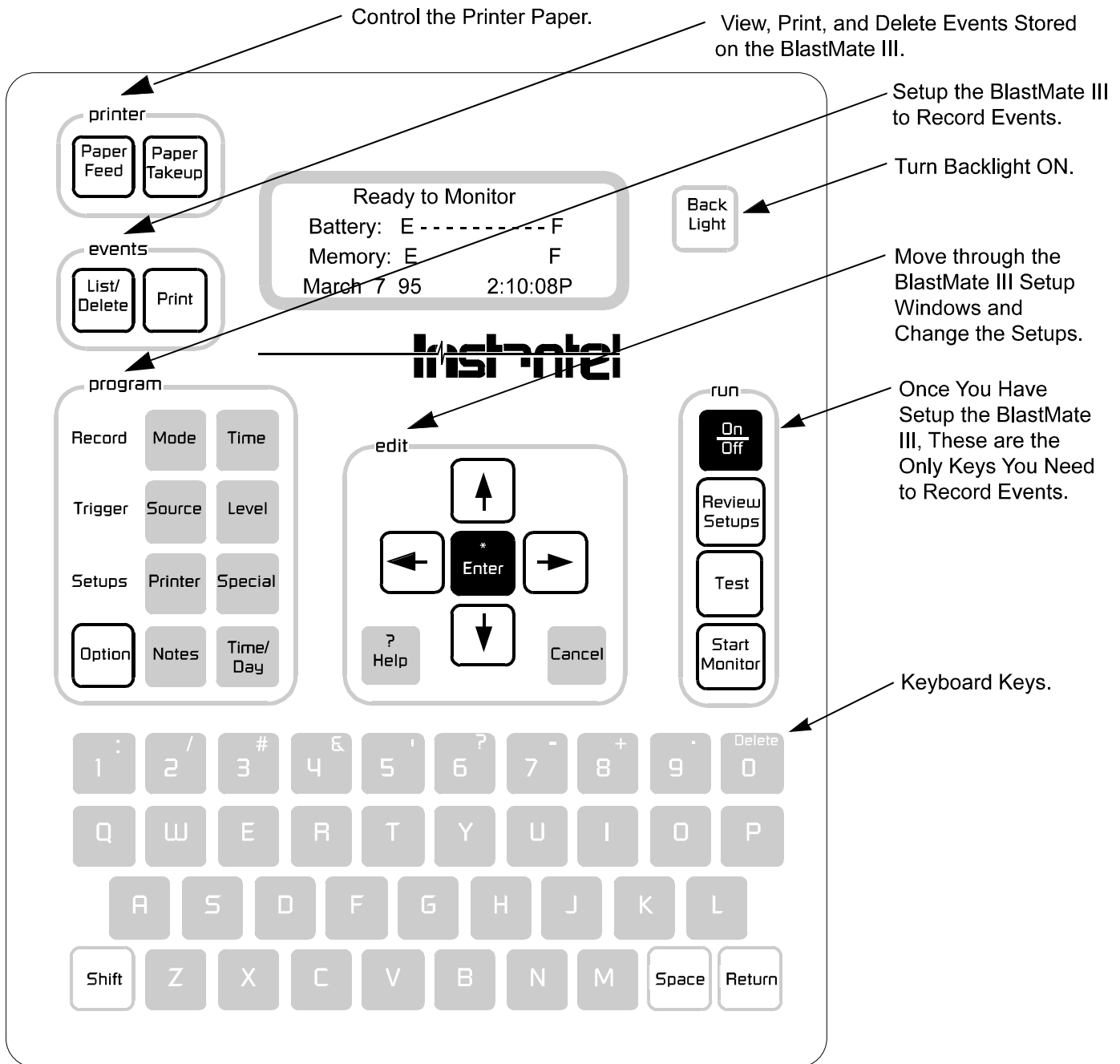

Figure 1.2 The BlastMate III Keys.

## 2. BASIC TUTORIAL

In this tutorial, you will learn how to turn on and setup the BlastMate III to record an event and then print an Event Summary Report. Follow this tutorial to practice event monitoring. You can also use it as a guide when recording actual events.

### Step 1: Install the BlastMate III

Unpack your the BlastMate III. Attach the ground spikes to standard transducer. Point the standard transducer in the direction of the event. For this tutorial, point it away from yourself. Press on the top of the standard transducer to force the ground spikes fully into the ground. Using a level, check that the standard transducer is level. Attach the standard transducer cable to the GEO connector on the front of the BlastMate III. Screw the microphone stand sections together and attach the microphone to the stand. Aim the front of the microphone towards the event. In our case, aim it away from yourself. Insert the microphone stand into the holder located on the front of the BlastMate III keeping it in an upright position. Attach the microphone cable to the MIC connector located on the front of the BlastMate III.

If you have an eight channel monitor, connect the sensors to the monitor according to the instructions contained in the BlastMate III and MiniMate Plus™ Sensors, Adapters, Splitters, and Extension Cables manual (714U3201).

### Step 2: Turn the BlastMate III On

Press and hold the **On/Off** key, located on the BlastMate III keyboard, until you hear an audible beep. A Start Up Window displays for three seconds followed by the Main Window display. The Start Up Window shows the BlastMate III serial number, operating software version, amount of installed memory, and the number of events stored in the BlastMate III.

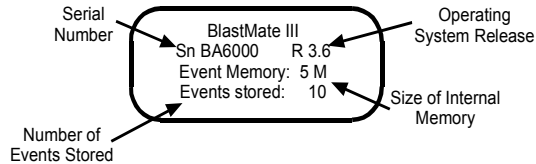

Figure 2.1 The BlastMate III Start Up Window.

The Main Window tells you the BlastMate III is ready to monitor. It also indicates battery power level, how full the memory is, date, and time. This is your starting window whenever you setup the BlastMate III. From here, you access all setups.

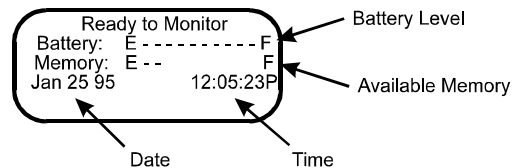

Figure 2.2 The BlastMate III Main Window.

### Step 3: Check Your Installation

Check your installation by pressing the **Test** key. This executes the Sensorcheck program and tests the standard transducer and microphone. The message “All Channels Working. Unit OK” appearing on the display tells you that your installation is level.

## Step 4: Review Setups

Before we begin, let us review the current BlastMate III setups. To review setups, press the **Review Setups** key. The current setups scroll past on the BlastMate III display. You can pause the display by pressing the **Enter** key. To continue the review, press the **Enter** key again.

## Step 5: Change BlastMate III Setups

After reviewing the setups, we have decided to change them, specifically the record mode, trigger source, trigger levels, record stop mode, the time, and the date. To change these setups, follow the steps below.

### a) Change the Record Mode

The BlastMate III has five record modes: Single Shot, Continuous, Manual, Histogram and Histogram Combo. We want to change the record mode from single shot to continuous. Single shot record mode records one event and stops. In continuous record mode, the BlastMate III records multiple events until you stop monitoring or the monitor runs out of memory.

To change the record mode, press the **Record Mode** key with the Main Window displayed. Press the **Up** or **Down Arrow** key to scroll through the Recording Mode Windows until the Continuous Window appears. Press the **Enter** key to select this record mode. The BlastMate III is now set to record in the continuous record mode.

### b) Choose a Trigger Source

By choosing a trigger source, you set the BlastMate III to trigger and start recording on either ground vibrations, measured by the standard transducer or sound pressure, measured by the microphone. The trigger source may be the standard transducer, microphone, or both the standard transducer and microphone.

To choose a trigger source, press the **Trigger Source** key with the Main Window displayed. Use the **Up** or **Down Arrow** key to scroll through the Trigger Source Windows until the Geophone/Microphone Window appears. Press the **Enter** key to select this trigger source.

### c) Set the Trigger Levels

The BlastMate III uses a trigger level, chosen by you, to automatically start recording when an event's activity exceeds this preset level. For our purposes, we will set an arbitrary trigger level for the standard transducer and the microphone.

To set the trigger level, press the **Trigger Level** key when the Main Window is displayed. Set the Geo trigger level to 3.0 mm/s using the **Right Arrow** key to move the cursor and the **Up Arrow** key to change the trigger level number. Press the **Enter** key to save your setting. The Mic Trigger Level Window appears. Set the Linear Mic trigger level to 100 dB using the **Right Arrow** key to move the cursor and the **Up Arrow** key to change the trigger level number. Press the **Enter** key to save your setting. If you have an eight channel monitor, the Geo2 and Mic2 trigger level windows appear. Repeat the above procedure.

### d) Choose a Record Stop Mode

Choose a record stop mode if using the single shot or continuous record modes. The record stop mode sets how the BlastMate III stops recording after being triggered. You can choose between a Fixed Record Time setting or an Auto Record setting. Fixed Record Time sets the record time to a specified length. In Auto Record, unlike the Fixed Record Time, the BlastMate III continues to record event activity as long as that activity remains above the trigger level. We will set a fixed record time of two seconds.



---

To set the record time, press the Record **Time** key when the Main Window is displayed. Press the **Up** or **Down Arrow** key to display the Fixed setting. Press the **Enter** key. The Record Time Window appears. Enter a record time of two seconds. Press the **Enter** key to save this setting.

### e) Set the Current Time

The BlastMate III supports the twelve hour, 11:55:23 PM, and twenty four hour, 23:55:23, time formats. You can choose either format.

To set the time, press the **Time/Day** key when the Main Window is displayed. Use the **Right** or **Left Arrow** key to move the cursor and the **Up** or **Down Arrow** key to set the current time. To select either the 12 or 24 hour time format, position the cursor under the AM/PM/24 hour indicator. Press the **Up Arrow** key to display the required setting. Press the **Enter** key to save your setting.

### f) Set Today's Date

The BlastMate III supports the Month/Day/Year date format.

To set the date, press the **Time/Day** key when the Main Window is displayed. Press the **Enter** key to display the Date Window. Use the **Right** or **Left Arrow** key to move the cursor and the **Up** or **Down Arrow** key to set today's date. Press the **Enter** key to save your setting.

## Step 6: Record Events

At this point, you are ready to record events. Press the **Start Monitor** key to begin monitoring. To see an event being recorded, clap your hands once in front of the microphone. The BlastMate III beeps indicating an event's activity has exceeded the trigger level. The event's results appear on the BlastMate III display. The BlastMate III then returns to the monitoring mode ready to record another event. Now bump the standard transducer. Again, the BlastMate III beeps. The results appear on the display and the BlastMate III returns to the monitoring mode. Press the **Cancel** key to stop monitoring.

We have just recorded two events and stored them in the BlastMate III memory. In the next steps, we view these events and print their Event Summary Reports.

## Step 7: View the Events

Let us view the events we just recorded. From the Main Window, press the Events **List/Delete** key. Press the **Enter** key to display the most recently recorded event. In our tutorial, this is the one we triggered by bumping the transducer. Next, press the **Up** or **Down Arrow** key to display the event we recorded caused by clapping our hands in front of the microphone. We would like to print all the events stored in the BlastMate III at once, so we will follow the next step to print the events.

## Step 8: Print the Events

After viewing the events, let's print copies of each event to obtain their Event Summary Reports. From the Main Window, press the Events **Print** key. Press the **Up** or **Down Arrow** key to scroll through the windows until the Print All Events Window appears. Press the **Enter** key to print all events. At the bottom of the display, the BlastMate III indicates how many events will be printed and which event is currently printing.

## **Step 9: Turn the BlastMate III Off**

We are finished with the BlastMate III after printing the Event Summary Reports, so let's turn it off. Press the **Cancel** key to return to the Main Window. Press and hold the **On/Off** key until the display disappears. The BlastMate III is now turned off.

## **Step 10: Interpret the Event Summary Report**

The Event Summary Report provides important information about an event. Many areas of the report can be custom designed including the report's title using the BlastWare III software; see the software operator manual for further information. You can also choose which information appears on the Event Summary Report including the BlastMate III setup information, waveform printing, frequency plots, and Sensorcheck results. See the Setups Printer section for more information.

***Congratulations, you are now a BlastMate III Compliance User.***

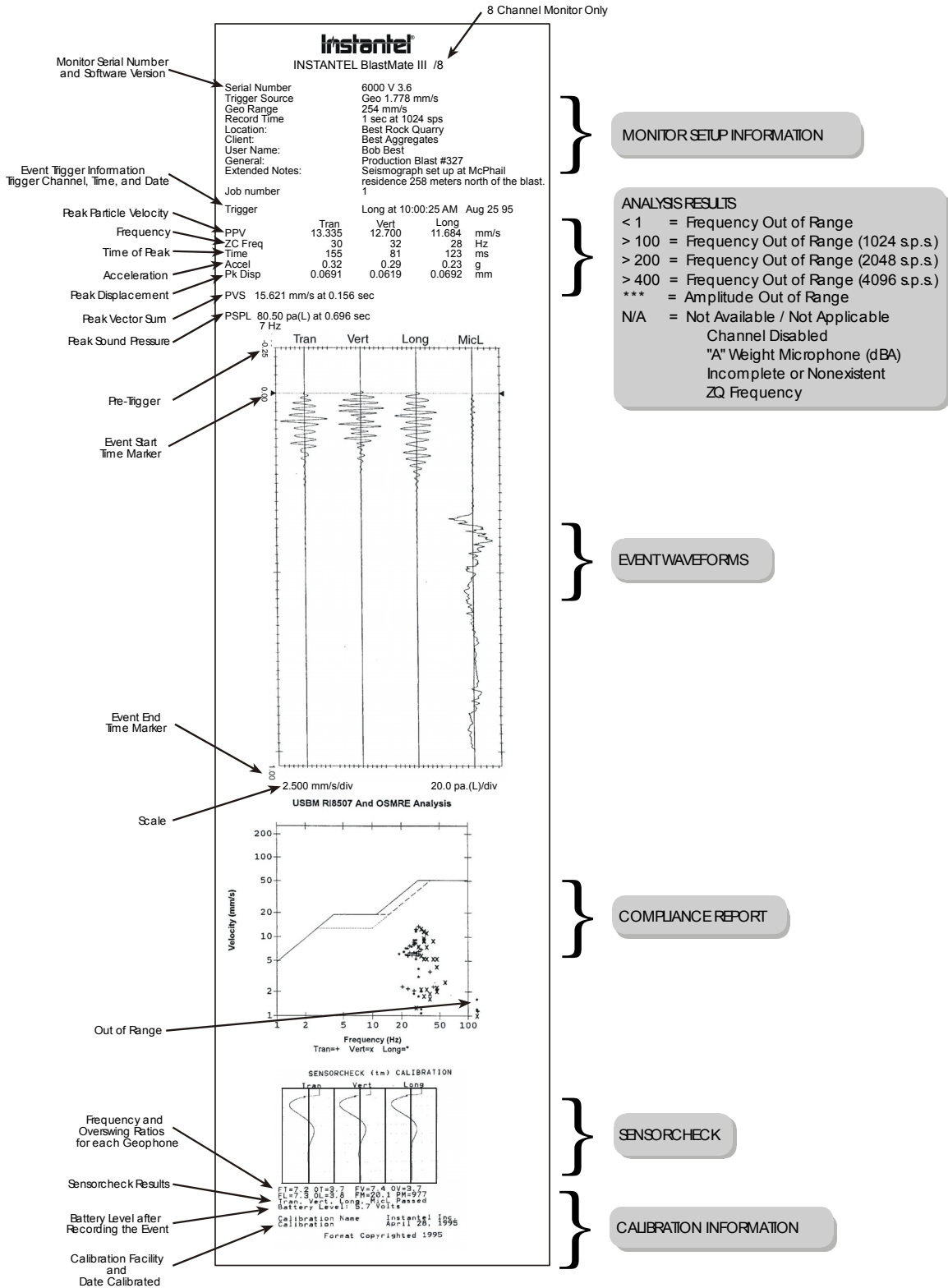

Figure 2.3 BlastMate III Event Summary Report.

**Notes:**

### 3. COMPLIANCE MODULE

This chapter provides instructions to install and setup the BlastMate III.

#### 3.1. What is Event Monitoring?

Event monitoring measures both ground vibrations and air pressure. The monitor measures transverse, vertical, and longitudinal ground vibrations. Transverse ground vibrations agitate particles in a side to side motion. Vertical ground vibrations agitate particles in an up and down motion. Longitudinal ground vibrations agitate particles in a forward and back motion progressing outward from the event site. Events also affect air pressure by creating what is commonly referred to as “air blast”. By measuring air pressures, we can determine the effect of air blast energy on structures, measured on the Linear “L” scale, or as perceived by the human ear, measured on the “A” Weight scale.

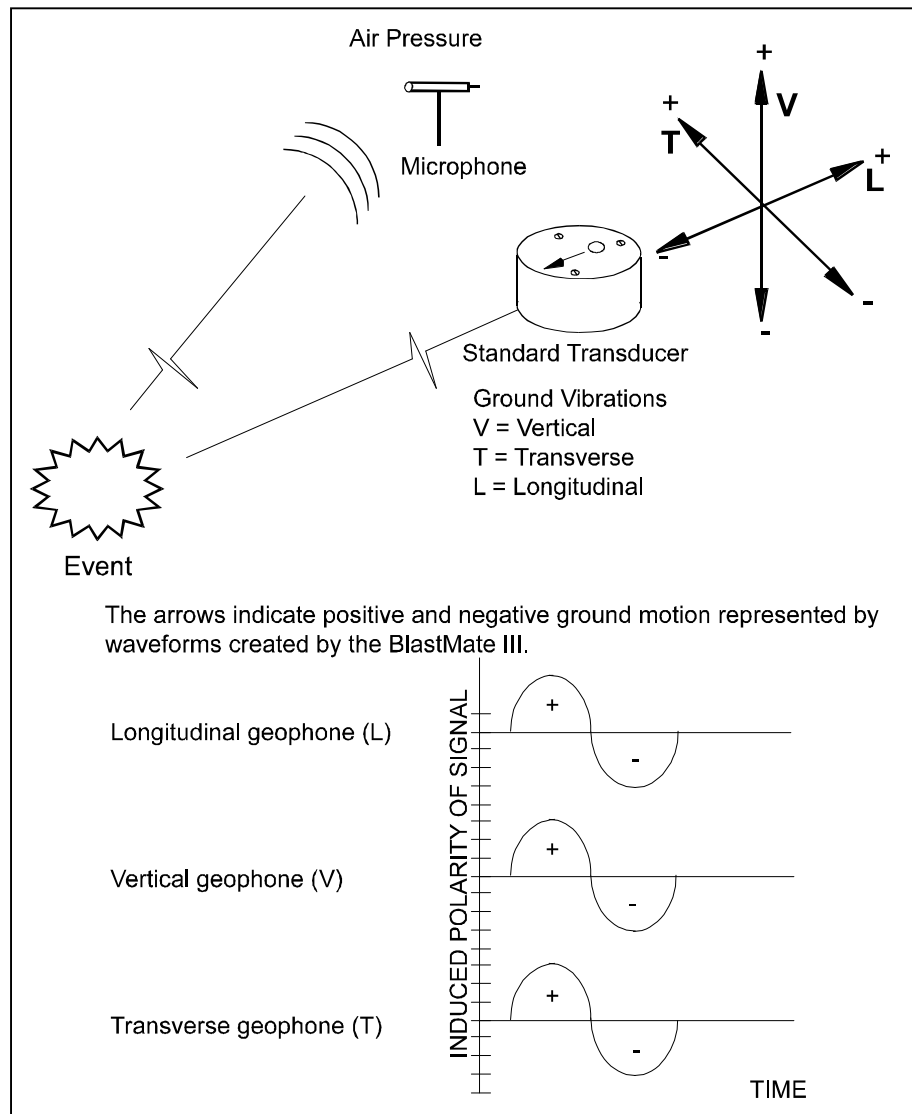

Figure 3.1 How the BlastMate III Monitors Events.

## 3.2. Eight Channel Models

The BlastMate III eight channel monitor offers a second set of four channels for compliance monitoring. A second microphone and a second standard transducer may be connected to these channels. For clarity, the number two (2) follows all references to the second microphone or second standard transducer throughout this manual.

For most monitoring operations, setting up and using the monitor is the same for both four and eight channel models. Where differences do occur, this manual specifies both the four and eight channel procedures.

**Note:** When using only four channels on eight channel monitors, always connect the sensors to channels one to four (CH 1–4).

## 3.3. Installing the Standard Transducer

The following sections apply to the standard transducer as supplied by Instatel. The sections illustrate coupling methods recommended by Instatel. Your particular monitoring activities may employ one or a combination of all of the following methods. You may even devise your own coupling method for a specific application. It is important for you to couple securely to ensure reliable monitoring results.

The following sections provide example installation methods. For wall and ceiling installations, refer to the Reference chapter. Other methods may be used if they satisfy the following requirements.

### 1. Arrow Pointed in Direction of the Event

The arrow on the top of the standard transducer must be pointed in the direction of the event to ensure the geophone sensors, located inside the standard transducer, remain in their natural axis.

### 2. Level Installation

The standard transducer must be mounted level. An optional leveling plate is available with three leveling feet and an integrated bubble level indicator.

### 3. Securely Coupled to the Surrounding Surface

The standard transducer must be securely coupled to the surrounding surface. The surface must be compact with no loose or soft material close to the standard transducer. Coupling is critical for reliable and accurate monitoring results. Insufficient coupling allows the standard transducer to move independently of the surrounding surface resulting in distorted, often higher, monitoring results.

Coupling methods depend upon the type of surface with no single method applicable to all types. It is up to you to check the surface and mount the standard transducer with sufficient coupling to ensure reliable monitoring results.

### 4. BlastMate III Protected from Water

The BlastMate III is splash resistant and designed to withstand temporary exposure to rain. It is not waterproof and should not be immersed in water. Immersing the monitor or installing the monitor where standing water may accumulate may damage the monitor.

### 3.3.1. Soft Surface Installations

Always install and use the ground spikes provided with the standard transducer. For the best coupling, bury the standard transducer.

### a. Using the Ground Spikes

Screw the three ground spikes into the bottom of the standard transducer and tighten. Point the arrow located on the top of the standard transducer in the direction of the event. Press on the top of the standard transducer to push the spikes fully into the ground. Check the standard transducer to ensure it is securely in place and level. Press the **Test** key to run Sensorcheck.



Figure 3.2 Installing the Standard Transducer using the Ground Spikes.



Figure 3.3 Final Installation with Ground Spikes Pushed Fully into the Ground.

### b. Burying the Standard Transducer

You can bury the standard transducer to couple it to the ground and prevent movement. The ground must be hard and compact with no loose material between the standard transducer and the compact ground material. Dig a hole from four inches (10 cm) to six inches (15 cm) deep. Attach the ground spikes to the standard transducer. Position the standard transducer in the hole with the arrow pointing toward the event. Press the ground spikes fully into the ground. Level the standard transducer. Compact the material around the standard transducer while back filling to securely couple to the surrounding ground material. Press the **Test** key to check your sensors.

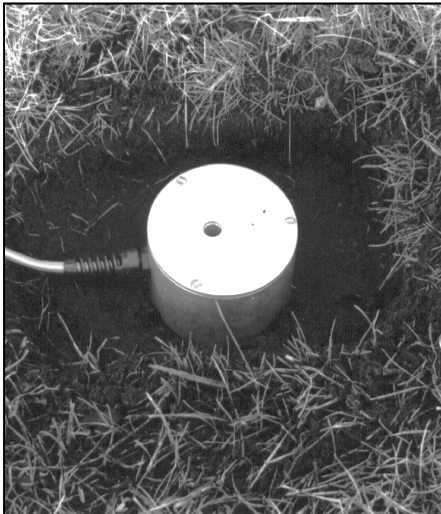

Figure 3.4 Burying the Standard Transducer.



Figure 3.5 Fill In and Pack the Material around the Standard Transducer.

### 3.3.2. Hard Surface Installations

For hard surface installations, such as rock, concrete or solid ice, the preferred installation method bolts the standard transducer to the surface. A second method, for very low level velocities only, uses a sandbag placed over the standard transducer.

#### a. Bolting the Standard Transducer

A standard transducer may be bolted to a surface alone or with the aid of the optional leveling plate. Position the standard transducer with leveling plate, if attached, on the surface and mark the position of the mounting bolt. Use a 3/8 inch (9.5 mm) bolt or threaded rod. Mount the bolt according to the manufacturer's instructions. Slide the standard transducer, and leveling plate, over the bolt. Slide a 3/8 inch (9.5 mm) washer and a 3/8 inch (9.5 mm) lock washer over the bolt. If using the leveling plate, level the standard transducer using the leveling feet and integrated bubble level. Tighten the retaining nut to finish the installation. Press the **Test** key to check your sensors using Sensorcheck.

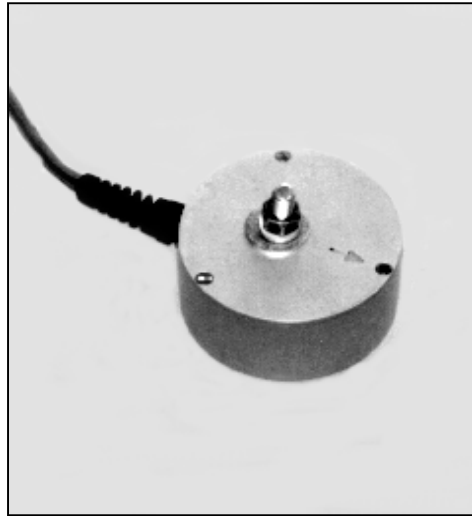

Figure 3.6 Bolting the Standard Transducer to a Surface.

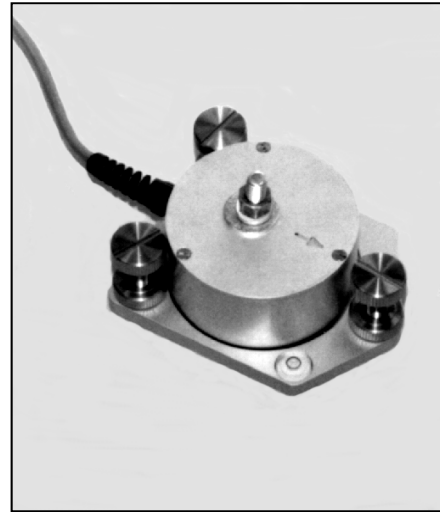

Figure 3.7 Bolting the Standard Transducer to a Surface using the Leveling Plate.

#### b. Sandbagging – For Very Low Velocity Levels Only

Use this method for installations where velocity levels remain very low. The sandbag must be of sufficient size to cover the entire standard transducer and lay on the surrounding surface around the standard transducer. A sandbag should contain at least 25 pounds (12 kg) of sand or 1/4" washed gravel. The optional leveling plate can be used with the method. Press the **Test** key to check your sensors using Sensorcheck.

## 3.4. Installing a Microphone

Instantel microphones come with a sectional three foot (one meter) mounting stand. Screw the three mounting stand pieces together. Locate the mounting stand at the point of interest. The mounting stand may be inserted into the support bracket located on the front of the BlastMate III or it can be pressed into the ground. Check that the stand is firmly positioned and installed upright. Insert the microphone into the mounting bracket on the top of the stand, and attach the windscreen to reduce false triggering caused by wind. Point the microphone in the direction of the event. Connect the microphone cable to the BlastMate III. Press the **Test** key to check your microphone and the microphone connection.

**NOTE:** The microphone windscreen attenuates the microphone reading by 0.2 dB. In most cases, this does not have a material impact on results.



**WARNING:** Handle the microphone with care. Dropping the microphone or otherwise subjecting it to impact may damage the microphone element. The windscreen can help to protect the microphone, and its use is recommended.

### 3.5. The BlastMate III Keyboard

The integrated keyboard offers convenient access to all the BlastMate III operations. The keyboard has sixty four keys with additional functions accessed by pressing two keys at the same time. The BlastMate III provides a confirmation beep when a key is pressed. Refer to the keyboard diagram located in Chapter 1.

You can change the BlastMate III setups using the keyboard or using a personal computer running the BlastWare III software. This section outlines the procedures to change the setups using the BlastMate III keyboard. For information on how to change the setups using a personal computer, refer to the BlastWare III software operator manual.

### 3.6. Run Keys

The Run keys control the most often used BlastMate III functions including turning the BlastMate III On and Off, reviewing the BlastMate III setups, testing the BlastMate III, and starting the BlastMate III to monitor. The following sections explain these functions in detail.

Once you have setup your monitor, these are the only keys you need to use to record events. They have a distinctive red color for easy location.

#### 3.6.1. On/Off Key

The **On/Off** key turns the BlastMate III on or off. To turn the BlastMate III ON, press and hold the **On/Off** key until an audible beep sounds. To turn the BlastMate III OFF, display the main window then press and hold the **On/Off** key until two audible beeps sound.

When turning on the BlastMate III, you can display the Main Window immediately by pressing the **Cancel** key after pressing the **Enter** key.

#### 3.6.2. Review Setups Key (Compliance Module Only)

Reviewing the BlastMate III setups scrolls you through its current settings. This provides you with the opportunity to check the setups without having to enter the individual window for each setting.

To review the setups, press the **Review Setups** key. The current setups scroll past on the BlastMate III display. You can pause the display by pressing the **Enter** key. To continue the review, press the **Enter** key again.

#### 3.6.3. Test Key (Compliance Module Only)

Pressing the **Test** key executes Sensorcheck and tests the BlastMate III and its sensors. Sensorcheck performs a two-stage test. In the first stage, the program displays the BlastMate III serial number, software version, the total amount of memory installed, the amount of memory available to store events, and the number of events presently stored in memory.

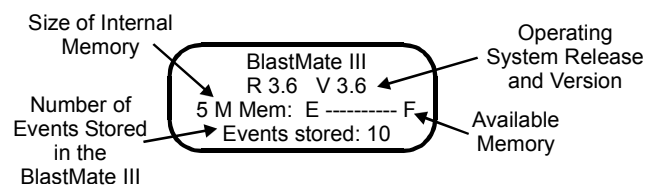

Figure 3.8 The Sensorcheck Window.

The second stage tests each geophone within the standard transducer and the microphone. The program also tests the operation of the BlastMate III itself and the standard transducer and

microphone connecting cables. The message “All Channels Working. Press Print to Print” indicates the BlastMate III passed the Sensorcheck.

### 3.6.4. Start Monitor Key

Press this key to enter the monitor mode. The BlastMate III is now waiting to record an event.

In manual record mode, the unit will display the following message when you press the Start Monitor key: “Press ‘\*’ to start, Cancel to abort.” Press the **Enter** key to begin monitoring.

You can view previously recorded events while the monitor is in the monitor mode. See the section describing the Event key, page 3–28.

## 3.7. Program Keys

The Program keys access the BlastMate III recording settings and allow you to change how the monitor records events.

### 3.7.1. Record Mode Key

The Record **Mode** key sets the record mode, sample rate, storage mode, and geophone range.

#### a. Record Mode

A record mode determines how the BlastMate III records events. The BlastMate III offers the following record modes.

##### (1) Single Shot Record Mode

Use single shot record mode to record one event automatically. The BlastMate III records the event, displays the results, and stops. No further recording occurs. Recording begins automatically when an event’s ground vibrations or air pressure exceeds the trigger level.

##### (2) Continuous Record Mode

Use continuous record mode to record multiple events automatically. The BlastMate III records an event, displays the results, and continues to monitor, ready to record following events. The BlastMate III records all events whose activity exceeds a preset trigger level.

##### (3) Manual Record Mode

Use manual record mode if automatic triggering is unreliable, due to excessive wind or nearby vehicle activity, or to record the background noise level in the vicinity of a site.

##### (4) Histogram (Strip chart) Record Mode

Use the histogram record mode for long-term recording periods such as monitoring pile driving operations. Histogram record mode operates with both four and eight channel monitors. Four channel histogram events can be printed by the monitor, eight channel events cannot. To print eight channel events, use the BlastWare III software program.

In this mode, the BlastMate III stores summary event information in intervals rather than in the real time continuous method used in the other record modes. The monitor samples data continuously at the chosen sample rate but only stores the relevant peaks for the interval. This reduces the data recorded to specific criteria only and greatly increases the monitor’s recording time. For each interval, the monitor calculates the maximum positive and negative peaks, the frequency of the largest peak, and up to two peak vector sums (one with four channel monitors, two with eight channel monitors). For each channel, the maximum peak, its frequency, and the largest peak vector sum is calculated over the entire event. Events may be printed in histogram or tabular mode. Histogram mode prints all peaks over the entire event along with the numerical results of the data analysis. In tabular mode, only the numerical results are printed.

**Note:** Histogram record mode consumes more battery power than the Single Shot, Continuous or Manual recording modes. We recommend connecting a monitor to the AC adapter or an external 12 VDC power supply.

### (5) Histogram Combo Record Mode

This mode creates a waveform during histogram recording if the signal exceeds the waveform trigger level. The waveform event is saved as a separate file while the histogram event file remains continuous. Up to 13 waveform events can be stored. The auxiliary trigger is disabled during histogram combo mode.

The maximum sample rates in this mode are as follows:

- a. 4 channels or less: 2048 samples per second
- b. more than 4 channels: 1024 samples per second

**Note:** Histogram Combo record mode consumes more battery power than the Single Shot, Continuous or Manual recording modes. We recommend connecting a monitor to the AC adapter or an external 12 VDC power supply.

#### To Select a Record Mode:

Press the Record **Mode** key. The Recording Mode Window. Press the **Up** or **Down Arrow** key to scroll through the record modes. Press the **Enter** key to select a record mode when it appears on the display.

### b. Sample Rate

The BlastMate III offers three sample rates: a standard rate of 1024 samples per second, a fast rate of 2048 samples per second, and a faster rate of 4096 samples per second (on channels 1 to 4 only). Increasing the sample rate increases the accuracy of the waveform recording. For this reason, set the sampling rate according to the location of the standard transducer. For close-in monitoring, set the sample rate to 4096 samples per second. For far-field monitoring, set the sample rate to 1024 samples per second.

Aliasing occurs when a high-frequency signal appears as an erroneous low frequency because the waveform was sampled at too low a sampling rate. An anti-aliasing filter solves this problem by removing the high-frequencies before they can appear at lower frequencies. The BlastMate III standard sensors have anti-alias sensors built into them to avoid this problem.

To choose a sample rate, press the Record **Mode** key. Press the **Enter** key to scroll through the windows until the Sample Rate Window appears. Use the **Up** or **Down Arrow** keys to display the required sample rate. Press the **Enter** key to select a rate.

### c. Storage Mode

The storage mode setting allows you to set the amount of data recorded with each event. In the Store Full Waveform setting, the BlastMate III records all event data. In the Store Summary Only mode, the BlastMate III records all event data **except** the waveforms and the Compliance Report.

**WARNING:** If you choose Store Summary Only, you will not be able to re-create the waveform.

To choose a Storage Mode, press the Record **Mode** key. Press the **Enter** key to scroll through the windows until the Storage Mode Window appears. Use the **Up** or **Down Arrow** keys to display the required storage mode. Press the **Enter** key to select a mode.

### d. Maximum Geo Range (Compliance Module Only)

The Maximum Geo Range specifies the measurement limits of the standard transducer's geophones. Two ranges are available: Sensitive 1.25 in/s (31.7 mm/s) and Normal 10.0 in/s (254

mm/s). Choosing a maximum geophone range depends on the proximity of the transducer to the event and the expected velocities.

To choose a maximum geophone range, press the Record **Mode** key. Press the **Enter** key to scroll through the windows until the Maximum Geo Range Window appears. Use the **Up** or **Down Arrow** keys to display the required maximum geophone range. Press the **Enter** key to select a range.

On eight channel monitors, set the Maximum Geo Range for the first four channels then set the Maximum Geo2 Range for channels five to eight.

### 3.7.2. Record Time Key

The Record **Time** key sets the record stop mode and histogram interval mode for the BlastMate III. Choose a record stop mode if using the single shot, continuous, or manual record modes. The histogram interval is required for the histogram and histogram combo modes.

#### a. Record Stop Mode (Single Shot, Continuous, and Manual Modes)

In single shot, continuous and manual record modes, the record stop mode sets how the BlastMate III stops recording after being triggered. You can choose between a Fixed setting or an Auto setting. Fixed sets the record time to a specified length. For example, you set the BlastMate III to record for two seconds in the Basic Tutorial. Once the record time has elapsed, the BlastMate III stops recording. In Auto, unlike in Fixed, the BlastMate III continues to record event activity as long as that activity remains above the trigger level (Sufficient memory and battery power must be available). Recording stops a specified period of time after the event activity falls below the trigger level. The specified period of time, called the Auto Window, can be adjusted (default = 3 seconds). See page 3–23.

Remember to set the record time long enough to record an entire event but not too long to avoid recording unnecessary data and filling the BlastMate III memory. Set a record time for single shot and continuous record modes.

A helpful rule of thumb when setting a record time for a blast event is to add the delays between detonating holes or use the longest delay, then add one second for each one thousand feet (300 m) from the event to the BlastMate III to account for the speed of sound. For example, in the figure below the minimum record time required is 1.1 seconds. To be on the safe side and ensure you record all the event's activity, set the record time to 2.0 seconds. There is no single method for setting a record time. Use your knowledge and experience to determine a record time.

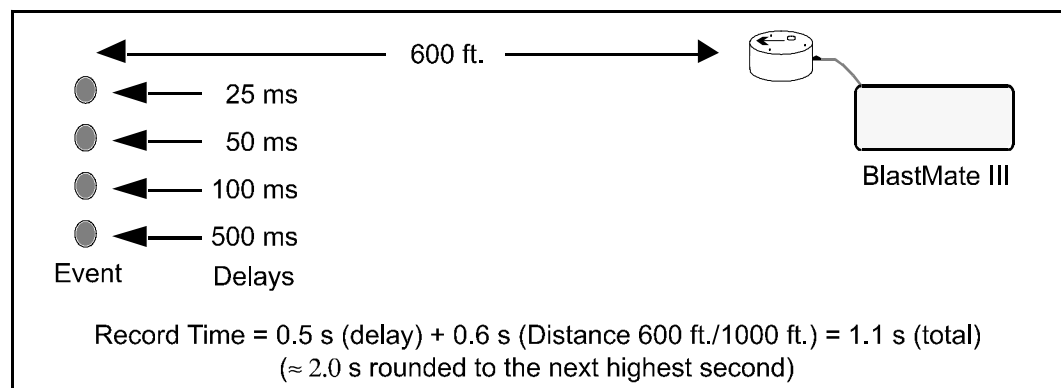

Figure 3.9 Calculating a Recording Time.

The total record time available depends upon the amount of available memory. The BlastMate III checks your setup to determine the amount of available memory. If there is not enough memory, a warning message appears and the record time defaults to the maximum available. For approximate record times, refer to the table appearing on page 4–2.

To set the record stop mode, press the Record **Time** key when the Main Window is displayed. Press the **Up Arrow** key to display either the Fixed Window or the Auto Window. Press the **Enter** key to select. If you chose Fixed, the Record Time Window appears. Use the **Right Arrow** key to move the cursor and the **Up Arrow** key to change the numbers to the required record time. Press the **Enter** key to save your setting.

## b. Histogram Interval (Histogram and Histogram Combo Modes)

In histogram and histogram combo record mode, the interval menu will be displayed instead of the record stop mode menu. The histogram interval is the period of time the monitor records event information before applying the data analysis techniques. For each interval, the monitor calculates the maximum positive and negative peaks, the frequency of the largest peak, and up to two peak vector sums (one with four channel monitors, two with eight channel monitors). For each channel, the maximum peak, its frequency, and the largest peak vector sum is calculated over the entire event.

The following table lists approximate recording times for the various histogram intervals. The table assumes 300 event (960 kB) available memory and sufficient power supplied to the monitor during recording.

As an approximation, if you increase the monitor's event memory to three megabytes, the values increase by a factor of three. If the monitor's memory is five megabytes, the values increase by an approximate factor of five. Increasing the sample rate to 2048 samples per second has no effect. If the recording channels increase to eight, the values decrease by approximately one half.

Memory Capacity – Histogram/Histogram Combo Record Mode*		
Histogram Interval	Continuous Recording Time (Days)	
	Histogram Mode	Histogram Combo Mode
2 seconds	1.1	0.9
5 seconds	2.8	2.4
15 seconds	8.5	7.3
1 minute	34	29
5 minutes	170	147
15 minutes	510	441

\* Sufficient power must be supplied to the monitor. See Calculating Battery Life in Appendix A.

### Increasing the Recording Time

You can increase the maximum recording time by turning off either the geophone or microphone channels or by using the timer. You can turn off either the geophone or microphone channels when this data is not required. Turning off the geophone channels increases the record time by 80%. Turning off the microphone channel increases the recording time by 20%. Using the timer can increase the recording time by recording only those time periods when events occur. For example, setting the timer to record for eight hour days only, increases the histogram record time by three times.

To set the histogram interval, ensure you have chosen the histogram record mode. Press the **Setups** key when the Main Window is displayed. Press the **Enter** key to display the Histogram Interval Window. Press the **Up** or **Down Arrow** keys to select an interval. Available intervals include 2, 5, and 15 seconds and 1, 5, and 15 minutes. Press the **Enter** key to save your setting.

**Note:** When exiting the histogram record mode, the last incomplete interval may not be saved. If the password feature is enabled, the last few intervals may not be saved.

### c. Record Time

The Record Time sets the length of time in seconds that the unit records if you have a selected a Fixed record stop mode. Once the record time has elapsed, the monitor stops recording. The maximum record time is displayed by the unit. Note that the maximum record time while in Histogram Combo Mode is 13 seconds.

### 3.7.3. Trigger Source Key

Choose a trigger source when using the Single Shot, Continuous and Histogram Combo record modes. The trigger source sets the BlastMate III to trigger and start recording an event automatically on ground vibrations, measured by a transducer, or air pressure, measured by a microphone. The BlastMate III has three trigger source settings: transducer alone (Geo), microphone alone (Mic), or both transducer and microphone together (Geo and/or Mic). When you choose both transducer and microphone together, triggering occurs and recording begins if an event's ground vibrations or air pressure exceeds the trigger level for either the transducer or the microphone.

For eight channel monitors, choosing a trigger source applies to both sensor groups. For example, choosing Geo as a trigger source designates both geophone transducers as trigger sources. Triggering occurs and event recording begins when event activity exceeds the trigger level of either geophone transducer.

To choose a trigger source, press the Trigger **Source** key when the Main Window is displayed. Press the **Up** or **Down Arrow** keys to scroll through the trigger sources. Press the **Enter** key to select a trigger source when it appears on the BlastMate III display.

### 3.7.4. Trigger Level Key

The trigger level sets a threshold that must be exceeded by an event's activity before the BlastMate III begins recording. Set a trigger level for the trigger source or sources chosen above.

Use your judgment when setting the trigger level. You must set the level high enough so the BlastMate III does not trigger on unwanted events such as nearby vehicle traffic. At the same time, you have to set the trigger level low enough so that an event's activity exceeds the trigger level and starts the BlastMate III recording. Available trigger level ranges appear in the specifications located in the Appendix of this manual.

To set the trigger level, press the Trigger **Level** key when the Main Window is displayed. The Geo Trigger Level or the Mic Trigger Level Window appears depending on the trigger source chosen above. Press the **Right** or **Left Arrow** key to move the cursor and the **Up** or **Down Arrow** key to change the numbers. Press the **Enter** key to save your setting. If both the geophone and microphone were chosen as trigger sources, pressing the **Enter** key saves the Geo Trigger Level setting and then displays the Mic Trigger Level Window. Set the microphone trigger level and press the **Enter** key to save your setting.

On eight channel monitors, set the geophone and microphone trigger levels for the first four channels then set the geo2 and mic2 trigger levels for channels five to eight.

### 3.7.5. Setups Printer Key

The Setups **Printer** key controls the BlastMate III printing and the contents of the Event Summary Report produced by the BlastMate III printer. You could, for example, print the same event with any combination of the following setups. To configure the settings, follow the steps outlined below.

### a. Print Events

This sets the printer to print one copy of an event automatically after recording or during histogram recording. Choose After Each Event to print automatically after recording an event. If you do not want automatic printing, choose On Request Only.

To set when to print events, press the Setups **Printer** key when the Main Window is displayed. The Print Event Window appears. Press the **Up** or **Down Arrow** key to display the On Request Only or After Each Event choices. Press the **Enter** key to select a choice when it appears on the display.

### b. Number of Copies

This sets the number of copies printed for each Event Summary Report. The number of copies ranges from one to ten. You can also print any number of copies of an event manually by pressing the Events **Print** key while viewing an event.

**Note:** If you have the Print After Each Event option selected, the monitor prints one event automatically regardless of the number of copies selected here.

To set the number of copies to be printed, press the Setups **Printer** key when the Main Window is displayed. Press the **Enter** key repeatedly to display the Number of Copies Window. Use the **Up** or **Down Arrow** keys to set the number of copies to be printed. Press the **Enter** key to save your setting.

### c. Setup Printout

This setting controls the printing of the current BlastMate III setups in the Event Summary Report. You can choose to include the setup information on every recorded event's Event Summary Report by selecting the Include on Printout setting. You can also choose not to print the BlastMate III setup information on the Event Summary Report by choosing the Do Not Include setting.

To choose a setting, press the Setups **Printer** key when the Main Window is displayed. Press the **Enter** key repeatedly to display the Setup Printout Window. Press the **Up** or **Down Arrow** keys to display the required setting on the BlastMate III display. Press the **Enter** key to select and save the displayed setting.

### d. Waveform Plot

This setting controls the printing of the event waveform plots in single shot, continuous, and manual record modes. The waveform plots are graphical representations of the activity recorded on each of the recording channels. Choose the Include on Printout setting to print the graphic waveforms on the Event Summary Report. If you do not want to print the waveforms, choose the Do Not Include setting.

To choose a setting, press the Setups **Printer** key when the Main Window is displayed. Press the **Enter** key repeatedly to display the Waveform Plot: Window. Press the **Up** or **Down Arrow** keys to display the required setting on the BlastMate III display. Press the **Enter** key to select and save the displayed setting.

### e. Histogram Printout (Compliance Module Only)

When using histogram or histogram combo record mode, choose Print Graphics to print a histogram for each recorded interval. Choose Print Tabular Data to print numerical results of the data analysis for each interval. If you do not require printing of histogram record mode results, choose No Graphics or Data.

Histogram recording requires sufficient battery power and printer paper during monitoring. For example, recording for one hour in two second intervals, the printout is approximately one foot (30 cm) long. The BlastMate III continues to record event information even if the paper runs out. You can print the results at a later time, after refilling the paper, using the Events **Print** key.

To increase monitoring times, we recommend that you connect the AC adapter or an external battery to the monitor and turn off the printing by choosing No Graphics or Data.

To choose a setting, press the Setups **Printer** key when the Main Window is displayed. Press the **Enter** key repeatedly to display the Histogram Printout: Window. Press the **Up** or **Down Arrow** keys to display the required setting on the BlastMate III display. Press the **Enter** key to select and save the displayed setting.

#### f. **Compliance Report (Compliance Module Only)**

The BlastMate III can include a Compliance Report, also called a National Frequency Standard, in the Event Summary Report. Choose the Include on Printout setting to include the Compliance Report in the Event Summary Report. If you do not require the Compliance Report, choose the Do Not Include setting. To select a Compliance Report for your jurisdiction, use the BlastWare III software operator manual.

To choose a setting, press the Setups **Printer** key when the Main Window is displayed. Press the **Enter** key repeatedly to display the Compliance Report: Window. Press the **Up** or **Down Arrow** key to display the required setting on the BlastMate III display. Press the **Enter** key to select and save the displayed setting.

#### g. **Sensorcheck Plot (Compliance Module Only)**

The Sensorcheck Plot is a graphical representation of the Sensorcheck test of each geophone. You can choose to include the Sensorcheck Plot in the Event Summary Report or not. The Sensorcheck numerical results always appear on the report.

Press the Setups **Printer** key when the Main Window is displayed. Press the **Enter** key repeatedly to display the Sensorcheck Plot: Window. Press the **Up** or **Down Arrow** key to scroll through the settings to display the required setting on the BlastMate III display. Press the **Enter** key to select and save the displayed setting.

### 3.7.6. **Setups Special Key**

The Setups **Special** key configures the BlastMate III timer, daily self check, Sensorcheck, measurement system, basic channels, microphone type, microphone units, geophone alarm level, microphone alarm level, serial connection and baudrate.

#### a. **Timer Mode**

The timer function sets the BlastMate III to automatically turn on and start monitoring operations at a preset time in the future. The timer can be set for a one time monitoring session or it can be set to record at the same time everyday. Using the timer extends the BlastMate III battery life by turning on and monitoring only the time periods when events occur and not the time periods between events. It also minimizes the recording of false events from other sources.

To stop timer recording at any time, press the **Cancel** key.

##### (1) **Monitor Once Only**

To set the BlastMate III to monitor at some time in the future, press the Setups **Special** key when the Main Window is displayed. Press the **Down Arrow** key to display the Monitor Once Only Window. Press the **Enter** key to display the Monitor Start Time Window. Enter the start time for monitoring operations to begin. Use the **Right** or **Left Arrow** key to move through the date and time displays. Use the **Up** or **Down Arrow** key to change the settings. Press the **Enter** key to save the Monitor Start Time setting and display the Monitor Stop Time Window. Enter the stop time for monitoring operations to end. Use the **Right** or **Left Arrow** key to move through the date and time displays. Use the **Up** or **Down Arrow** key to change the settings. Press the **Enter** key to save the stop time setting. Press the **Start Monitor** key to enter the timer mode. The timer is now set to



start monitoring operations automatically according to your start and stop dates and times. The monitor displays the following window:

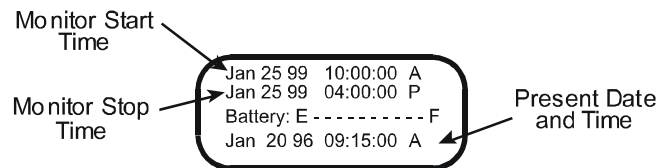

Figure 3.10 Timer Mode Window – Monitor Once Only.

## (2) Monitor Everyday

To set the BlastMate III to monitor at the same time each day, press the Setups **Special** key when the Main Window is displayed. Press the **Down Arrow** key to scroll through the windows until the Monitor Everyday Window appears. Press the **Enter** key to turn the timer on and display the Daily Start Time Window. Use the **Right** or **Left Arrow** key to move the cursor and **Up** and **Down Arrow** key to change the hour and minute settings. Press the **Enter** key to save your start time. The Daily Stop Time Window appears. Use the **Right** or **Left Arrow** key to move the cursor and the **Up** or **Down Arrow** key to change the hour and minute settings. Press the **Enter** key to save your stop time. Press the **Start Monitor** key to enter the timer mode. The BlastMate III is now set to start and stop monitoring operations automatically at the same time everyday. The monitor displays the following window:

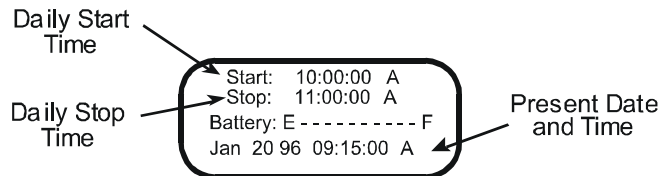

Figure 3.11 Timer Mode Window – Monitor Everyday.

## b. Daily Self Check (Compliance Module Only)

Use the Self Check mode for remote monitoring where you require a record indicating the monitor was operating properly over a period of time.

Daily Self Check must be enabled for adjustment of the unit's real-time clock speed. The Self Check mode program operates when the monitor is in the monitor mode; the monitor temporarily exits the monitor mode, at the same time each day specified by you, performs the check, and returns to monitor mode. The results appear in a monitor log entry.

To select the self check mode, use the **Right Arrow** key and simultaneously press the **Setups** key, then press **Enter** to except the Timer Mode setting: Daily Self Check mode is now available – use the **Up Arrow** or **Right Arrow** to toggle between Enabled and Disabled options, and **Enter** to save the desired setting. If you select Enabled, the next screen prompts for a time to be entered. Use the **Right Arrow** to move the cursor between hours and minutes, and the **Up Arrow** to change the time, then press **Enter** to save your changes.

## c. Sensorcheck (Compliance Module Only)

This setting chooses when to automatically run Sensorcheck to test the monitor and its sensors. You can run Sensorcheck manually by pressing the **Test** key. You can choose not to run Sensorcheck, to run Sensorcheck after recording each event, or only once before monitoring starts. If you choose Disabled, Sensorcheck does not run and the sensors are not checked. If you choose After Each Event, Sensorcheck runs after recording each event. Results are saved with each event and appear on the monitor display. If you choose Before Monitoring, Sensorcheck runs once before monitoring starts, when you enter the monitor mode. The results of this single Sensorcheck appear with each event recorded during the monitoring session. This reduces processing time, by

not having to run Sensorcheck for each event, and speeds up recording especially when using the continuous record mode.

To set when to run Sensorcheck, press the Setups **Special** key when the Main Window is displayed. Press the **Enter** key to scroll through the windows until the Sensorcheck: Window appears. Press the **Up** or **Down Arrow** key to display the Disabled, After Each Event, or Before Monitoring choices. Press the **Enter** key to select a choice when it appears on the BlastMate III display.

#### **d. Measurement System (Compliance Module Only)**

The BlastMate III uses the Metric or Imperial measurement system.

To choose either Metric or Imperial units, press the Setups **Special** key when the Main Window is displayed. Press the **Enter** key repeatedly to scroll through the windows until the Measurement System: Window appears. Press the **Up** or **Down Arrow** key to display the Imperial or Metric choices. Press the **Enter** key to select a choice when it appears on the BlastMate III display.

#### **e. Basic Channels (Compliance Module Only)**

You can operate four and eight channel monitors with all recording channels on or you can turn off either the geophone or microphone recording channels. On eight channel monitors, choosing to turn off either the geophone or microphone channels turns off all geophone channels (channels 1, 2, 3, and 5, 6, 7) or both microphones (channels 4 or 8). Also, all channels can be turned off except one or two geophone channels.

You may, for example, turn off the microphone if you are monitoring inside a building where the microphone is not applicable. This reduces the amount of memory required to save and store a single event and therefore increases the overall number of events the BlastMate III can record and store.

To turn basic channels on or off, press the Setups **Special** key when the Main Window is displayed. Press the **Enter** key repeatedly to scroll through the windows until the Basic Channels: Window appears. To monitor with only one or two geophone channels, choose the Geophone Channel 1 or Geophone Channels 2 option. Choose 4 Channels ON on four channel monitors or 8 Channels ON on eight channel monitors to disable this feature. Another Basic Channels window appears.

On eight channel monitors, press the **Up** or **Down Arrow** keys to select either four or eight recording channels. Press the **Enter** key. Press the **Up** or **Down Arrow** key to display the choices. Choose the All Channels On setting to record events with all the geophone and the microphone channels on. Choose the Geo Channels OFF setting to record events without recording information from the geophone channels. Choose the Mic Channel OFF setting to record events without the microphone turned on. To choose a setting, display it on the BlastMate III display then press the **Enter** key.

#### **f. Microphone Type (Compliance Module Only)**

Two types of microphones may be connected to the BlastMate III: Linear “L” and “A” Weight. The BlastMate III must be configured to the microphone type being used to ensure the proper measurement units and data analysis techniques are used during recording. This setting tells the BlastMate III which microphone you are using. To check the type of your microphone, read the label on the side of the microphone. All Instantel microphones have a model number. *Lin Mic* identifies a linear microphone. *A Mic* identifies an “A” Weight microphone.

To select a microphone type, press the Setups **Special** key when the Main Window is displayed. Press the **Enter** key repeatedly to scroll through the windows until the Microphone Type Window appears. Press the **Up** or **Down** key to display the two microphone types, Linear or “A” Weight.

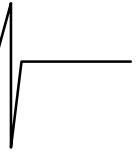

To choose a setting, display it on the BlastMate III display and press the **Enter** key. On eight channel monitors, set the microphone type for the second microphone, Mic2.

#### **g. Microphone Units (Compliance Module Only)**

The measurement units used on the microphone channel depend on the microphone type and measurement system being used. For Linear “L” microphones, you have the choice between psi (L), dB (L), or pa. (L). For “A” weight microphones, units are dB (A) only. For this reason, when you chose the “A” Weight microphone type, this window does not appear on the BlastMate III display.

To choose a microphone measurement unit, press the Setups **Special** key when the Main Window is displayed. Press the **Enter** key repeatedly to scroll through the windows until the Microphone Units: Window appears. Press the **Up** or **Down Arrow** key to display the three microphone unit choices. Press the **Enter** key to select a measurement unit when it appears on the display.

#### **h. Geophone Type (Compliance Module Only)**

Two types of geophone may be connected to the BlastMate: a Standard Geophone or a 4.5 Hz Geophone.

To select a geophone type, press the **Right Arrow** key and the **Setups** key together. Press the **Enter** key to scroll the windows until the Geophone Type Window appears. Press the **Right Arrow** key to display the two microphone types, Standard or 4.5 Hz. To choose a setting, display it on the BlastMate III display and press the **Enter** key.

Note that for the 4.5 Hz Geophone, the unit will perform a continuity test when Sensorcheck is run instead of the standard Sensorcheck test.

#### **i. Geo Alarm Level (Compliance Module Only)**

The Geo Alarm Level controls the triggering of an optional remote alarm (711A1401). On eight channel monitors, the geo alarm level operates on channels one to four only.

The remote alarm sounds two alarms: warning and alarm. The warning alarm sounds when event activity exceeds the geophone trigger level. The geophone alarm level can be set to a higher level than the geophone trigger level. This allows for the triggering of a second alarm at the higher level.

For example, in pile driving operations the remote alarm triggers a warning when activity exceeds the trigger level for the geophone, notifying the operator that the pile driving activity has exceeded that set level. The second alarm triggers when activity exceeds the geophone alarm level, set to a higher level, notifying the operator that operations should cease immediately.

To set the geophone alarm level, press the Setups **Special** key when the Main Window is displayed. Press the **Enter** key repeatedly to scroll through the windows until the Geo Alarm Level Window appears. Use the **Up** or **Down** and **Left** or **Right Arrow** keys to set the alarm level. Press the **Enter** key to save your setting.

#### **j. Mic Alarm Level (Compliance Module Only)**

The Mic Alarm Level controls the triggering of an optional remote alarm (711A1401). On eight channel monitors, the Mic Alarm Level operates on channels one to four only.

The remote alarm sounds two alarms: warning and alarm. The warning alarm sounds when event activity exceeds the microphone trigger level. The Mic Alarm Level can be set to a higher level than the microphone trigger level. This allows for the triggering of a second alarm at a higher level. See the Geo Alarm Level section, above, for an example.

To set the Mic Alarm Level, press the Setups **Special** key when the Main Window is displayed. Press the **Enter** key repeatedly to scroll through the windows until the Mic Alarm Level Window

appears. Use the **Up** or **Down** and **Left** or **Right Arrow** keys to set the alarm level. Press the **Enter** key to save your setting.

#### **k. Serial Connection**

This sets the BlastMate III to communicate with a computer using the BlastMate III PC Connecting Cable (712A2301) or via a modem over telephone lines or radio frequencies. You must set the BlastMate III to the proper serial connection before starting communications. To communicate with a computer using the connecting cable, choose the Direct setting. To communicate using modems, choose the Via Modem setting. Set the baud rate on the monitor to match the baud rate of your computer or modem.

To choose the serial connection, press the Setups **Special** key when the Main Window is displayed. Press the **Enter** key repeatedly to scroll through the windows until the Serial Connection: Window appears. Press the **Up** or **Down Arrow** key to display the two choices. Select Direct if you are connecting to a computer with the BlastMate cable or Via Modem if you are using modems. Press the **Enter** key to select a choice when it appears on the display.

#### **l. Direct Baudrate or Modem Baudrate**

This sets the baudrate for the serial connection method chosen in the previous step, either direct or via modem. For direct, choose a baudrate of 38400. For modem communications, choose a baudrate supported by the modems you are using.

#### **m. Call Home**

This setting is used to setup the monitor for use with the Auto Call Home feature of the BlastWare III software. With Auto Call Home, your monitor can be setup to automatically download results either after an event, or at specified times. You must have a modem and phone line connected to the unit in order to use this feature. In addition, you must setup Auto Call Home within BlastWare III on your PC. Please refer to the BlastWare III Operator Manual (p/n 714U0301) for information on how to configure Auto Call Home and setup modems for use with a monitor.

To turn Call Home on, select Enabled. If you do not wish to use this feature, select Disabled.

To set Call Home, press the Setups **Special** key when the Main Window is displayed. Press the **Enter** key to scroll through the windows until the Call Home: Window appears. Press the **Up** or **Down Arrow** key to display either Enabled or Disabled. Press the **Enter** key to save your setting.

**Note:** Auto Call Home is supported by BlastMate III units with a serial number of 6000 or higher.

#### **n. Call Home Test**

This menu becomes available when the Call Home feature is enabled. It offers you a collection of tools to configure and test your Auto Call Home setup to ensure that it is working properly. BlastWare III must be running on your PC, and Auto Call Home must be active in order to test your setup.

To set Call Home Test, press the Setups **Special** key when the Main Window is displayed. Press the **Enter** key to scroll through the windows until the Call Home Test: Window appears. Press the **Up** or **Down Arrow** key to display the desired setting. Press the **Enter** key to save your setting. Four selections are available: 1) Do Not Call Now, 2) Call Now, 3) Call Now and Monitor, and 4) Set Signal Strength.

##### **(1) Do Not Call Now**

Select this setting if you do not wish to test your Auto Call Home setup.

##### **(2) Call Now**

This setting will cause the unit to call in to your PC as soon as you press the **Enter** key. The messages “power up delay...” and “connecting...” will appear as the unit first communicates with

the modem and then connects to your PC to download events. A message appears telling you whether or not downloading was successful.

### (3) Call Now and Monitor

With this setting, the unit calls in to your PC as in Call Now, and then enters monitor mode.

### (4) Set GSM Signal Strength

This setting is used to test the signal strength of GSM (cellular) modems. Press the Enter key to display signal strength from the modem, and then press Cancel when you are done.

## o. Beep When Triggered

This menu allows you to select whether or not the unit will emit a beep when triggered. Select On to activate beeps, and Off to turn them off.

To set Beep When Triggered, press the Setups **Special** key when the Main Window is displayed. Press the **Enter** key to scroll through the windows until the Beep When Triggered Window appears. Press the **Up** or **Down Arrow** key to select a choice, and then press **Enter** key.

## 3.7.7. Option Key

The **Option** key, when used in combination with other keys, provides additional setups.

## 3.7.8. Option Key + Special Key

Pressing the **Option** key and the **Special** key at the same time accesses advanced functions including reset factory defaults, auto window, auxiliary trigger, backlight on time, power saving timeout, and monitoring LCD cycle.

### a. Reset Factory Defaults

This function returns all the BlastMate III setups to the original factory defaults. If you choose to reset the monitor, all of your setups will be lost and replaced with the factory defaults. You can reprogram your setups again anytime you want.

**WARNING:** Resetting the Factory Defaults deletes your existing setups. Your setups will be lost.

To reset factory defaults, press the **Option** key and the **Special** key together when the Main Window is displayed. The Reset Factory Defaults Window appears. Press the **Enter** key to continue or the **Cancel** key to exit. Press and hold the **Enter** key to reset the factory defaults.

### b. Auto Window

The Auto Window operates when the trigger level is set to Auto. The Auto Window determines the length of time the BlastMate III continues to record after an event's activity falls below the trigger level. This ensures that an event's delayed activity, particularly air blast, is recorded. For example, if you plan to record an event at a long distance from the source, set the Auto Window to a large value to compensate for the time required for the air blast to travel from the source to the monitor's microphone. If you set the value to a small value, the monitor may stop recording after the seismic activity reaches the monitor but before the air blast reaches it. The Auto Window values range from one to nine seconds.

To set the Auto Window, press the **Option** key and the **Special** key together when the Main Window is displayed. Press the **Cancel** key to exit the Reset Factory Defaults Window and display the Auto Window. Use the **Up** or **Down Arrow** key to change the value. Press the **Enter** key to save your setting.

### c. Password

This feature activates a password control requiring an operator to enter a password before being able to exit the monitor mode. The password prevents an unauthorized exit from monitor mode.

while still allowing an operator to view event summaries. Password control can be enabled or disabled. The default password is “3bm”. Passwords can be one to four alphanumeric characters in length including spaces. Passwords can be enabled in all monitoring modes except the advanced mode.

To display the password feature, press the **Option** key and the **Special** key together when the main window is displayed. Press the **Cancel** key to exit the Reset Factory Defaults Window and display the Password Window. Use the **Up** or **Down Arrow** key to display Enabled to turn the password on or Disabled to turn the password off. If enabled, enter a password then press the **Enter** key to save your setting. You have ten seconds to enter the password.

#### d. Auxiliary Trigger

The auxiliary trigger is an external triggering mechanism used to start monitor recording.

A variety of optional auxiliary triggers are available including the DS 20 Wire Trigger (677A9601), and the BlastMate Trigger Cable (712A3901) used to connect several monitors together for multiple point blast monitoring.

To use the auxiliary trigger, set the monitor in the single shot or continuous record mode. Set a fixed record time. The auxiliary trigger does not operate in the auto record time setting. Press the **Option** key and the **Special** key together when the Main Window is displayed. Press the **Cancel** key to exit the Reset Factory Defaults Window and display the Auto Window. Press the **Enter** key to display the Auxiliary Trigger Window. Use the **Up** or **Down Arrow** key to display Enabled to turn the auxiliary trigger on or Disabled to turn the auxiliary trigger off. Press the **Enter** key to save your setting.

#### e. Backlight On Time

This command sets the length of time the backlight remains on. If enabled, the backlight turns on by pressing the **Back Light** key. An adjustable timer, from 0 to 255 seconds, determines the length of time the backlight remains on. To disable the backlight and not have it turn on, set the timer delay to 0. This conserves battery power.

To set the backlight timer, press the **Option** key and the **Special** key together when the Main Window is displayed. Press the **Cancel** key to exit the Reset Factory Defaults Window. Press the **Enter** key repeatedly to display the Backlight On Time Window. Use the **Up** or **Down Arrow** keys to change the time setting. Press the **Enter** key to save your setting.

#### f. Power Saving Timeout

The Power Saving Timeout is a timer that automatically turns the BlastMate III off when it has remained in the ready to monitor mode while detecting no key presses for a specified period of time. This conserves battery power. To turn the monitor on again, press and hold the **Enter** key.

To set the power saving timer, press the **Option** key and the **Special** key together when the Main Window is displayed. Press the **Cancel** key to exit the Reset Factory Defaults Window. Press the **Enter** key repeatedly to display the Power Saving Timeout Window. Use the **Up** or **Down Arrow** keys to change the time setting. Press the **Enter** key to save your setting.

#### g. Monitoring LCD Cycle

The Monitoring LCD Cycle is a timer that automatically starts a power saving mode. While in this mode, the monitor minimizes power consumption while continuing its monitoring operations. The monitor display cycles off for the time period set in this command, turns on momentarily, then cycles again. To turn this feature off, set the time to zero. To reactivate the monitor and see the display, press the **On/Off** key.

To set the monitoring LCD cycle, press the **Option** key and the **Special** key together when the Main Window is displayed. Press the **Cancel** key to scroll through the Reset Factory Defaults

---

window. Press the **Enter** key repeatedly to display the Monitoring LCD Cycle Window. Use the **Up** or **Down Arrow** keys to change the time setting. Press the **Enter** key to save your setting.

#### **h. Trigger Sample Width**

You can specify the number of consecutive samples that must exceed the trigger level before the unit will start recording. The default is 2 samples.

To set the trigger sample width, press the **Option** key and the **Special** key together when the Main Window is displayed. Press the **Cancel** key to scroll through the Reset Factory Defaults window. Press the **Enter** key repeatedly to display the Trigger sample width Window. Use the **Up** or **Down Arrow** key to change the setting. Press the **Enter** key to save your setting.

#### **i. Cut Cable Detection**

This setting is used to automatically disable a geophone channel as a trigger if the cable is cut or damaged. While in continuous record mode, the unit checks each geophone channel after an event is recorded. If there is a problem, the unit automatically disables that channel as a trigger source for subsequent events. This feature does not apply to the single-shot, manual, histogram or histogram combo modes.

To enable cut cable detection, press the **Option** key and the **Setups** key together when the Main Window is displayed. Press the **Cancel** key to exit the Reset Factory Defaults Window. Press the **Enter** key to scroll through the windows until the Cut Cable Detection Window appears. Use the **Up Arrow** key to change the setting. Press the **Enter** key to save your setting.

### **3.7.9. Option Key + Time/Day Key**

Pressing the **Option** key and the **Time/Day** key at the same time accesses the Clock Speed Adjust Window. This command allows you to make adjustments to the speed of the BlastMate III's internal clock.

Enter the number of seconds that the clock will be adjusted each day. Use the **Up** or **Down Arrow** key to first select positive or negative, and then enter the number of seconds using the **Arrow** keys. Positive numbers are added to the time and negative numbers are subtracted. Press the **Enter** key to save your setting.

**Note:** The Daily Self Check function must be activated in order for the time to be corrected. The time is adjusted as part of the Daily Self Check. Please see page 3–19 for information on how to activate the Daily Self Check.

### 3.7.10. Notes Key

The **Notes** key accesses the Notes and the Job Number features.

#### a. Notes

The **Notes** key lets you enter notes that are recorded with an event and printed in the Event Summary Report. You can choose to include notes in your Event Summary Reports by selecting the Use Notes choice. If you do not require notes, select the Use Blank Text Notes choice. With this chosen, the BlastMate III leaves the space on the Event Summary Report where the notes would have appeared. This allows you to write your own notes on the Event Summary Report in the space provided.

To configure this setting, press the **Notes** key. The Notes Format: Window appears. Press the **Up** or **Down Arrow** keys to display the two choices, either Use Notes or Use Blank Text Notes. Press the **Enter** key to save your setting.

If you chose Use Notes, the five notes windows appear in order allowing you to change the notes titles and add your notes using the BlastMate III keyboard. Each of the five windows identifies itself as either Notes 1, 2, 3, 4, or 5 Title with the default titles appearing under these. You can change the default titles to your own. Titles can be up to 20 characters in length. Move the cursor to the existing title and enter your new title. Press the **Shift + Delete** keys to delete characters. Press the **Enter** key to save your changes. The text area for each title appears after you have pressed the **Enter** key. The text area for the first four notes is 40 characters. Note 5 text area can be up to 640 characters. Enter your notes in these windows. Remember to press the **Enter** key to save your notes.

#### b. Job Number Format

You may include a job number for each recorded event. Job numbers help you keep track of events stored in the BlastMate III or in a computer. Job numbers range from 1 to 9999.

To display the Job Number Format Window, press the **Notes** key when the Main Window is displayed. Press the **Enter** key to scroll through the windows until the Job Number Format Window appears. To enter a job number, press the **Up** or **Down Arrow** key to display the Use Job Number setting. Press the **Enter** key to choose this setting. The Job Number Window appears. Enter a job number and press the **Enter** key. If you do not require job numbers, display the Don't Use Job Number setting and then press the **Enter** key.

#### c. Scaled Distance

Scaled distance information can be saved with each event and printed on the event summary report. The scaled distance information includes two factors: Distance from blast and Charge Weight. The Distance from blast factor is the measured distance from the blast charge to the monitor's sensors. The charge weight is the physical weight of the charge used.

To enter scaled distance information, press the **Notes** key when the Main Window is displayed. Press the **Enter** key to scroll through the windows until the Scaled Distance: Window appears. Press the **Up** or **Down Arrow** key to display the Use Scaled Distance Window. Press the **Enter** key. The Distance from blast Window appears. Use the **Arrow** keys to enter the distance from the blast to the monitor's sensors then press the **Enter** key. The Charge weight Window appears. Use the **Arrow** keys to enter the charge weight and press the **Enter** key to save your setting.

If you do not require the scaled distance information, choose the Omit Scaled Distance choice from the Scaled Distance Window.

### 3.7.11. Time/Day Key

The **Time/Day** key adjusts the BlastMate III time and date settings.



### a. Setting the Time

The BlastMate III supports the twelve hour, 11:55:23 PM, and twenty four hour, 23:55:23, time formats. You can use either format.

To set the time, press the **Time/Day** key when the Main Window is displayed. Use the **Right** or **Left Arrow** key to move the cursor and the **Up** or **Down Arrow** key to set the time. Press the **Up** or **Down Arrow** key to change the AM, PM, and 24 hour time formats. Press the **Enter** key to save your setting.

### b. Setting the Date

The BlastMate III supports the Month/Day/Year date format.

To set the date, press the **Time/Day** key when the Main Window is displayed. Press the **Enter** key to scroll through the windows until the Date: Window appears. Use the **Right** or **Left Arrow** key to move the cursor and the **Up** or **Down Arrow** key to set the date. Press the **Enter** key to save your setting.

## 3.8. Edit Keys

The Edit keys help you navigate through the BlastMate III menus, enter your changes, get on–line help information, and exit a procedure.

### 3.8.1. Enter \* Key

The **Enter \*** key scrolls through the BlastMate III windows, selects windows, and saves your settings. The key also lets you view previously recorded events while the monitor is in the monitor mode waiting for a trigger.

To view events while monitoring, press the **Enter** key. Data for the most recently recorded event appears on the display. Press the **Up** or **Down Arrow** key to display other events. Press the **Left** or **Right Arrow** key to display event data for other channels. Press and hold the key until you hear a beep confirming your key press. By default, event data appears in the following order. If you viewed event data before, the data displayed last appears first when you next view the event data.

1. Peak Particle Velocity (PPV) and Air Pressure.
2. Velocity and frequency results for all channels, displayed in pairs, beginning with channels 1 and 2. For advanced events, the velocity result appears only. Frequency is not calculated for advanced events.
3. Acceleration and peak displacement results for each channel displayed individually.
4. Peak vector sum results for channels 1, 2, 3 and channels 5, 6, 7.

**Note:** Channels 5, 6, 7, and 8 available on eight channel monitors.

### 3.8.2. Help Key

The BlastMate III offers you on–line help at every step. When using the BlastMate III, always look to the bottom of the display for information on the choices you have and which key to press.

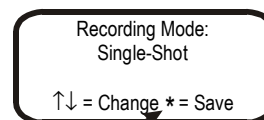

On-line Help Message  
**Figure 3.12 On – Line Help.**

### 3.8.3. Cancel Key

Use this key to return to the previous menu without changing settings. It can be pressed at any time during operations. Pressing the key a number of times always returns you to the Main Window. You can change a setting and return to the Main Window without scrolling through further windows.

Also, the **Cancel** key exits all monitoring modes. You may be requested to enter a password before you can stop monitoring. Press the **Cancel** key. The Password Window appears. You have ten seconds to enter the four character password. Enter the password then press the **Enter** key. This password protection can be enabled or disabled by pressing the Option + Special keys and choosing the Password command. See page 3–23.

### 3.8.4. Arrow Keys

The four arrow keys move you through the BlastMate III menus from one window to the next. Inside windows, the keys move the position of the cursor and change the value of the settings in the window.

## 3.9. Events Keys

The Events keys organize and print events stored in the BlastMate III.

### 3.9.1. List/Delete Key

The **List/Delete** key lists events stored in the BlastMate III so you can view them. The key also deletes all events stored in the BlastMate III.

#### a. View Events

To view events stored in the BlastMate III internal memory, press the **List/Delete** key when the Main Window is displayed. Press the **Enter** key to scroll through the windows until the View Events Window appears. This window indicates the total number of events stored in the BlastMate III. Press the **Enter** key to view events. Press the **Up** or **Down Arrow** key to scroll through the stored events. The most recently recorded events display first. You can also view events on the display while the monitor is in monitor mode, waiting for a trigger. See the section explaining the Enter key, above.

By default, event data appears in the following order. If you viewed event data before, the data last displayed appears first the next time you view events. Channels 5, 6, 7, and 8 require an eight channel monitor.

1. Peak Particle Velocity (PPV) and Air Pressure.

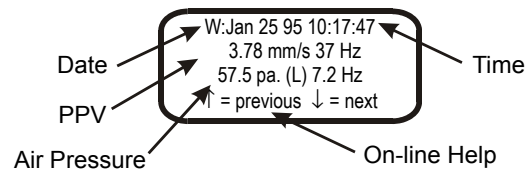

2. Velocity or air pressure results along with the frequency for all channels, displayed in pairs, beginning with channels 1 and 2. For advanced events, the velocity result appears only. Frequency is not calculated for advanced events.

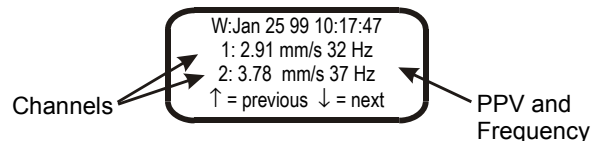

3. Acceleration and peak displacement results for each channel displayed individually.

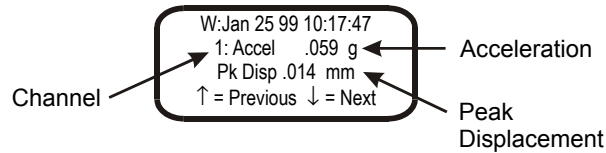

4. Peak vector sum results for channels 1, 2, 3 and channels 5, 6, 7 (eight channel monitor required).

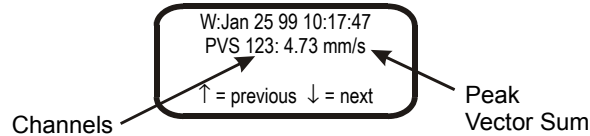

5. PPV for all enabled channels expressed in decibels, and Air Pressure. (Units with a serial number of 6000 or higher only.)

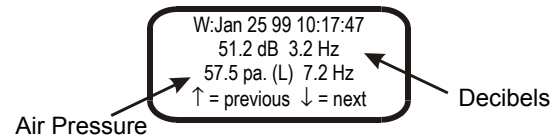

Figure 3. 13 The View Event Window.

## b. Delete All Events

Deleting all the events stored in the BlastMate III frees up internal memory space to record additional events.

**WARNING:** Once the events have been deleted, they cannot be recovered.

Be sure to protect your events by either printing them first to obtain a paper record or upload the events to a personal computer. If you upload the events, check that the events transferred properly and can be viewed and printed before deleting them from the BlastMate III. Remember to copy the Monitor Log before it is deleted with the other events.

To delete all the events stored in the BlastMate III, press the **List/Delete** key with the Main Window displayed. Press the **Up Arrow** key to scroll through the windows until the Delete All Events Window appears. Press the **Enter** key to begin the deletion. A second window appears asking you to hold the **Enter** key for five seconds to delete all the files. This window asks you to confirm your initial choice or exit without continuing. Press and hold the **Enter** key for five seconds to delete all events. Notice at the bottom of the window, a countdown indicator tells you the number of events being deleted.

## 3.9.2. Print Key

Press this key to print an Event Summary Report for all the events stored in the BlastMate III or for specified events only. It also prints an event list and a monitor log. You can stop printing at any time by pressing and holding the **Cancel** key. The BlastMate III completes printing the current event then stops.

### a. Print Last Event

You can print an Event Summary Report for last event recorded by the BlastMate III.

To print the last recorded event, press the Events **Print** key when the Main Window is displayed. Press the **Up** or **Down Arrow** keys to scroll through the windows to display the Print Last Event

Window. Press the **Enter** key to select this choice and begin printing. The display returns to the Print Last Event Window after printing finishes.

### b. Print Selected Event

You can select and print specific events stored in the BlastMate III.

To print one event, press the Events **Print** key when the Main Window is displayed. Press the **Up** or **Down Arrow** keys to scroll through the windows until the Print Selected Event Window appears. Press the **Enter** key to display the most recently recorded event. Press the **Up** or **Down Arrow** keys to scroll through the other events stored in the BlastMate III. To print an event, press the **Enter** key when it appears on the display. During printing, the event appears on the display along with the message "Printing Event". When printing finishes, the display returns to the Event Window where you can scroll through the stored events and choose another event to print, if desired.

### c. Print All Events

You can print an Event Summary Report for each event stored in the BlastMate III.

To print all the events, press the Events **Print** key when the Main Window is displayed. Press the **Up** or **Down Arrow** keys to scroll through the windows to display the Print All Events Window. Press the **Enter** key to select this choice and begin printing. During printing, the BlastMate III displays each event along with the total number of events to be printed. The display returns to the Print All Events Window after printing finishes.

### d. Print Event List

You can print an event list indicating all the events stored in the BlastMate III along with each event's date, time, and recording results.

To print the BlastMate III Events List, press the Events **Print** key when the Main Window is displayed. Press the **Up** or **Down Arrow** keys to scroll through the windows and display the Event List Window. Press the **Enter** key to print the event list.

MONITOR SERIAL NUMBER		Geo		Mic	
Time	in/s	Hz	dB	Hz	
Serial Number	1000				
August 7, 1995					
H:01:32A13	0.115V	6.20	104L	19.3	
h:11:32A08	0.111T	73	122L	43	
W:05:36P41	0.175T	64	141L	57	
w:11:19A30	160L	57	105L	7.4	
August 10, 1995					
H:02:34A23	0.115V	6.2	104L	19.3	
August 18, 1995					
W:11:34A23	160L	57	116L	57	

**EVENT TYPE**

- H = Histogram - Full Data
- h = Histogram - Summary Data
- W = Waveform - Full Data
- w = Waveform - Summary Data
- A = specifies Advanced Waveform
- \* = specifies Series II Waveform
- Arc = Archived Events
- Log = Monitor Log Entry

**TIME**

- A = A.M.
- P = P.M.
- : = 24 Hour

**MICROPHONE TYPE**

- L = Linear "L"
- A = "A" Weight

**ANALYSIS RESULTS**

- <1 = Frequency Out of Range
- >100 = Frequency Out of Range (1024 s.p.s.)
- >200 = Frequency Out of Range (2048 s.p.s.)
- >400 = Frequency Out of Range (4096 s.p.s.)
- \*\*\* = Amplitude Out of Range
- N/A = Not Available / Not Applicable
- Channel Disabled
- "A" Weight Microphone (dBA)
- Incomplete or Nonexistent ZC Frequency

**GEOPHONE CHANNEL**

- L = Longitudinal Geophone
- V = Vertical Geophone
- T = Transverse Geophone

Figure 3.14 Event List Printout.

### e. Print Monitor Log

The BlastMate III creates a Monitor Log indicating all the monitoring sessions including start times, stop times, and the times of all recorded events.

To print the monitor log, press the Events **Print** key when the Main Window is displayed. Press the **Up** or **Down Arrow** keys to scroll through the windows and display the Print Monitor Log Window. Press the **Enter** key to display the Monitor Log From Window. In this window, choose an event to start the event list. Use the **Right** or **Left Arrow** key to move the cursor and the **Up** or **Down Arrow** key to change the date and time settings. Press the **Enter** key to save your setting and display the Monitor Log To: Window. Choose an event to end the event list. Use the **Right** or **Left Arrow** key to move the cursor and the **Up** or **Down Arrow** key to change the date and time settings. Press the **Enter** key to save your setting and start printing the Monitor Log.

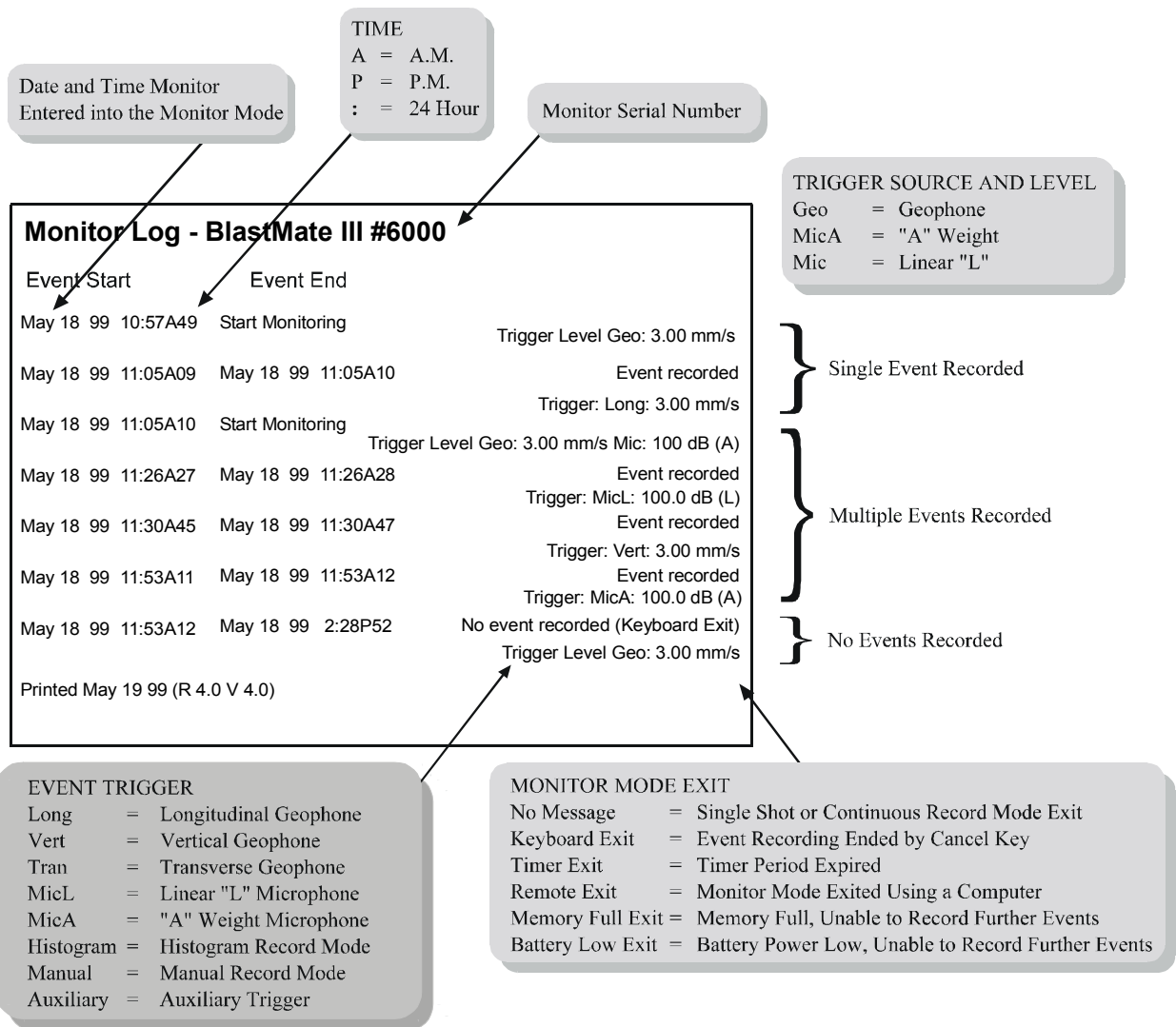

Figure 3.15 Monitor Log Printout.

## 3.10. Printer Keys

The Printer keys control the BlastMate III printer paper feed and roll takeup.

### 3.10.1. Paper Feed Key

Pressing the **Paper Feed** key advances the paper one line. Press and hold the key to rapidly advance the paper.

### 3.10.2. Paper Takeup Key

Pressing the **Paper Takeup** key rolls up the printed paper. Press and hold the key to rapidly takeup the paper.

## 3.11. Back Light Key

Pressing the **Back Light** key turns on the Back Light and illuminates the BlastMate III display. The length of time the light remains on is adjustable. See the Reference Chapter.

## 3.12. Keyboard Keys

A full alphanumeric keyboard lets you enter information into the BlastMate III. The shift key, space key, return key, and delete key follow standard keyboard conventions like on a personal computer.

## 4. ADVANCED MODULE

The advanced module is designed to smoothly combine with the compliance module. It adds features to the compliance module without changing the look and operation of the monitor. Before you can use the advanced features, you must load the advanced software into the monitor using the BlastWare III software's advanced module. Once completed, the following features may be changed in the field using the monitor alone. Please refer to the BlastWare III manual for complete instructions.

This section of the manual also builds on the previous compliance module section. The operations you performed using the compliance module are still available to you unless stated otherwise. Please refer back to the operations in the compliance module when operating the monitor in the advanced mode. This section outlines those features found only in the advanced module.

### 4.1. Option Key + Special Key

The **Option + Special** key combination adds the following menu item in the advanced mode.

#### 4.1.1. Instrument Mode

The instrument mode displays the current operating mode of the monitor. The mode can be changed between the Compliance and the Advanced operating modes. This display only appears if the monitor has been configured previously to operate in the advanced mode.

To display the monitor's current operating mode, press the **Option + Special** keys to display the Instrument Mode Window. The mode appearing is the current operating mode. To change the mode, press the **Up** or **Down Arrow** keys to display the other available mode. Press the **Enter** key to save your setting.

**Note:** The advanced software must be installed into the monitor first. See the BlastWare III manual for further information.

### 4.2. Test Key

This key tests the sensors connected to the monitor. Unlike in the compliance mode, the test checks each channel individually. You have to scroll through the channels to see the results of each.

To test the sensors, press the **Test** key. The message "Press Enter to Perform Channel Check or Cancel to Exit" appears on the monitor's display. Press the **Enter** key to continue. The following display appears:

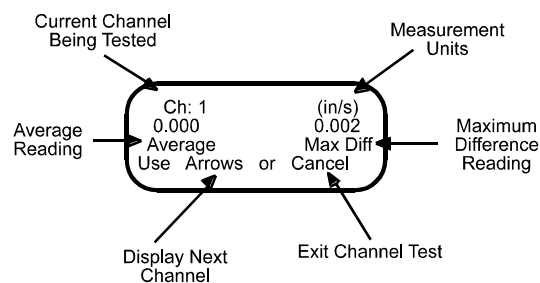

**Figure 4.1 Test Display for the Advanced Module.**

The monitor powers up the sensors and displays the average and maximum difference read from the sensors. This allows you to test the sensor by stimulating it (i.e., shaking a transducer or blowing into a microphone) and observing the response.

## 4.3. Record Mode Key

The Record **Mode** key sets the sample rate, and channel range.

### 4.3.1. Sample Rate

The BlastMate III offers a number of sample rates in the advanced mode including 512, 1024, 2048, 4096, 8192, 16384 samples per second (32768 and 65536 optional). When displaying sample rates, the monitor displays only those sample rates available with the current channel configuration. Histogram record mode supports the 1024, 2048 and 4096 sample rates only (the 4096 sample rate can only be used with a maximum of four enabled channels). The following table summarizes the sample rates and the channels that may be used. Note that some sample rates operate on specific channels only.

Sample Rate Availability				
Sample Rate	Channel 1 Only	Channels 1 – 2	Channels 1 – 4	Channels 1 – 8
65536	available	–	–	–
32768	available	available	–	–
16384	available	available	available	–
8192	available	available	available	available
4096	available	available	available	available
2048	available	available	available	available
1024	available	available	available	available
512	available	available	available	available

“–” indicates not available

To choose a sample rate, press the Record **Mode** key. Press the **Enter** key to scroll through the windows until the Sample Rate Window appears. Use the **Up** or **Down Arrow** keys to display the available sample rate. Press the **Enter** key to select a rate.

**Note:** Eight channel monitors have been optimized for sample rates up to 65536 samples per second. Four channel monitors may exhibit noise at sample rates greater than 16384 samples per second. Please contact the manufacturer for further information.

### 4.3.2. Channel Range

The Channel Range specifies the measurement limits of each channel. Two ranges are available: Sensitive (Gain=8) and Normal (Gain=1). Each channel may be set to a different range.

To choose a channel range, press the Record **Mode** key. Press the **Enter** key to scroll through the windows until the Channel Range Window appears. Use the **Up** or **Down Arrow** keys to display the required range. Press the **Enter** key to save the range and display the next channel. Continue until the ranges have been set for all channels.

## 4.4. Record Time Key

If you are using continuous, single shot or manual record mode, enter a fixed record time. Advanced operations do not offer the auto record mode. The monitor calculates the maximum available recording time based on the amount of installed RAM, chosen sample rate, and the amount of memory used by saved events.



To set the record time, press the Record **Time** key when the Main Window is displayed. The Record Time Window appears. Use the **Right Arrow** key to move the cursor and the **Up Arrow** key to change the numbers to the required record time. Press the **Enter** key to save your setting.

Maximum Record Times				
Sample Rate	Channel 1 Only	Channels 1 – 2	Channels 1 – 4	Channels 1 – 8
<b>1 Megabyte (300 Event)</b>				
65536	3 sec*	–	–	–
32768	13 sec	3 sec*	–	–
16384	26 sec	13 sec	3 sec*	–
8192	52 sec	26 sec	13 sec	3 sec*
4096	104 sec	52 sec	26 sec	13 sec
2048	208 sec	104 sec	52 sec	26 sec
1024	416 sec	208 sec	104 sec	52 sec
512	500 sec	416 sec	208 sec	104 sec
<b>5 Megabyte (1500 Event)</b>				
65536	20 sec	–	–	–
32768	60 sec	20 sec	–	–
16384	120 sec	60 sec	20 sec	–
8192	240 sec	120 sec	60 sec	20 sec
4096	480 sec	240 sec	120 sec	60 sec
2048	500 sec	480 sec	240 sec	120 sec
1024	500 sec	500 sec	480 sec	240 sec
512	500 sec	500 sec	500 sec	480 sec

“–” indicates not available \* may only record 2.9 seconds

## 4.5. Trigger Source Key

Choose a trigger source when using the single shot or continuous record modes. The trigger source sets the BlastMate III to trigger and start recording an event automatically when an event’s activity exceeds the trigger level for a channel. In advanced mode, you can choose any number of channels as trigger sources.

To choose a trigger source, press the Trigger **Source** key when the Main Window is displayed. The Trigger Source Window appears. Press the **Up** or **Down Arrow** to display the required channel. Choose to enable or disable the channel. Press the **Enter** key to save your setting and display the next recording channel. Continue until the trigger source is disabled or enabled on all the recording channels. Set a trigger level for each trigger source chosen; see below.

## 4.6. Trigger Level Key

The trigger level sets a threshold that must be exceeded by an event’s activity before the BlastMate III begins recording. Set a trigger level for each channel chosen as a trigger source.

To set the trigger level, press the Trigger **Level** key when the Main Window is displayed. The Trigger Level Window appears. Press the **Right** or **Left Arrow** key to move the cursor and the **Up** or **Down Arrow** key to change the numbers. Press the **Enter** key to save your setting and display the next recording channel. Continue to set a trigger level for each recording channel.

## 4.7. Setups Special Key

The Setups **Special** key sets the timer mode, advanced channels, serial connection and baudrate. The timer mode, serial connection, and baudrate operate the same in the advanced mode as they do in the compliance mode. Please refer to page 3–18 in Compliance Module for additional information.

### 4.7.1. Advanced Channels

This turns certain recording channels on or off. You can choose Channel 1 only, Channels 1 and 2, Channels 1 through 4, and Channels 1 through 8 (eight channel monitor required).

To turn the channels on or off, press the Setups **Special** key when the Main Window is displayed. Press the **Enter** key repeatedly to scroll through the windows until the Advanced Channels: Window appears. Press the **Up** or **Down Arrow** key to display the choices. To choose a setting, display it on the BlastMate III display then press the **Enter** key.

---

## 5. REFERENCE

This chapter discusses wall and ceiling installation procedures, and the theory of operation for Instantel's standard transducer, microphone, Sensorcheck, anti-alias filter, and data analysis techniques.

### 5.1. Additional Installation Procedures

The following sections outline procedures to install the standard transducer on walls and ceilings.

#### 5.1.1. Standard Transducer Wall Installation

Refer to the installation illustration below and follow the instructions to install the standard transducer and wall mount kit.

**To complete this installation you will need the following tools:**

1. Hammer
2. 19mm (3/4 inch) deep-throated socket and ratchet
3. 13mm (1/2 inch) wrench
4. 12mm (.47 inch) drill bit and drill

- (1) Using the Geophone Wall Mount as a template, orient the block as shown, and mark the location of the two holes to be drilled.
- (2) Remove the Geophone Wall Mount, and drill two 12mm (.47 inch) diameter holes; drill the holes to a depth of 89mm (3.50 inches).
- (3) Place a nut on the end of each wedge anchor bolt to protect the threads, and using a hammer, securely drive each bolt into place. Ensure that at least 32mm (1.25 inches) of each of the wedge anchor bolt threads extend from the wall.
- (4) Remove the nuts from the wedge anchor bolts, and reposition the Geophone Wall Mount. Secure it using two washers, the two nuts previously removed, and a deep-throat socket with a ratchet.
- (5) Position the Geophone (not included in this kit) on top of the Geophone Wall Mount, aligning the through-hole of the geophone with the mount; secure it using the bolt, washer, and wing nut. Hand-tighten the wing nut – DO NOT use a wrench or pliers to tighten the wing nut, as this may damage the Geophone.

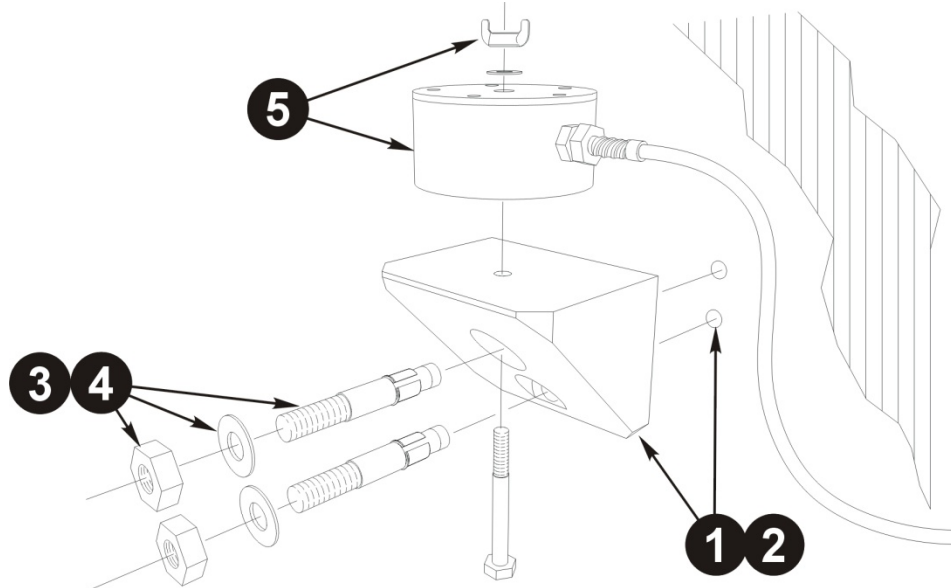

**NOTE:** To install the Geophone Wall Mount, dependent on your application, you may need to acquire alternative mounting hardware than what has been provided with this kit.

### 5.1.2. Standard Transducer Ceiling Installation

You can install the standard transducer on a ceiling by itself or with the optional leveling plate where leveling adjustments are required.

The transducer may be installed on level ceilings where no leveling adjustments are required. To mount a transducer, install a bolt into the ceiling according to the manufacturer's instructions. Hold the transducer in the upright position and slide it over the bolt. This ensures the vertical geophone, located inside the transducer, maintains its original axis. Point the arrow in the direction of the event. Slide on 3/8 inch (9.5 mm) washer and a 3/8 inch (9.5 mm) lock washer over the bolt and tighten with the retaining nut. Press the **Test** key to check your sensors using Sensorcheck.



**Figure 2 Installing the Standard Transducer on a Ceiling Right Side Up.**

The standard transducer may also be mounted on a ceiling using the leveling plate. This requires optional extended leveling feet for the leveling plate. Secure the standard transducer to the

leveling plate with the three screws provided. Remove the existing leveling feet and replace with the extended leveling feet. Screw the leveling feet through the bottom of the leveling plate. Place the assembly on the ceiling with the transducer right side up and the arrow pointing in the direction of the event. Mark the position of the bolt. Install the bolt into the ceiling according to the manufacturer's instructions. Slide the leveling plate with the transducer over the bolt. Slide a 3/8 inch (9.5 mm) washer and a 3/8 inch (9.5 mm) lock washer over the bolt. Screw on the retaining nut to hold the unit in position. Level the assembly by adjusting the leveling feet. The integrated bubble level cannot be seen when installing the leveling plate on a ceiling. Use a level to check the installation. Tighten the retaining nut on the bolt to secure the installation. Press the **Test** key to check your sensors using Sensorcheck.

## 5.2. Theory of Operation

This section describes how InstanTel's transducer and microphone operate. It also discusses InstanTel's Sensorcheck program, anti-alias filter, and the data analysis techniques used to calculate monitoring results.

### 5.2.1. Transducer

A transducer measures ground vibrations. The actual mechanism inside the transducer is called a geophone. Transducers have either one geophone, called uniaxial transducers, or three geophones, called standard transducers.

#### a. Geophone Operation

Functionally a geophone sensor is a coil of wire suspended around a magnet. The magnet is free to move in a field of magnetic flux lines. By Lenz's Law, induced voltage is proportional to the speed at which flux lines are traversed. Induced coil voltage is therefore proportional to the relative velocity of the coil to the magnet. In practice, it does not matter whether the coil or the magnet moves. Only the motion and speed relative to each other are important.

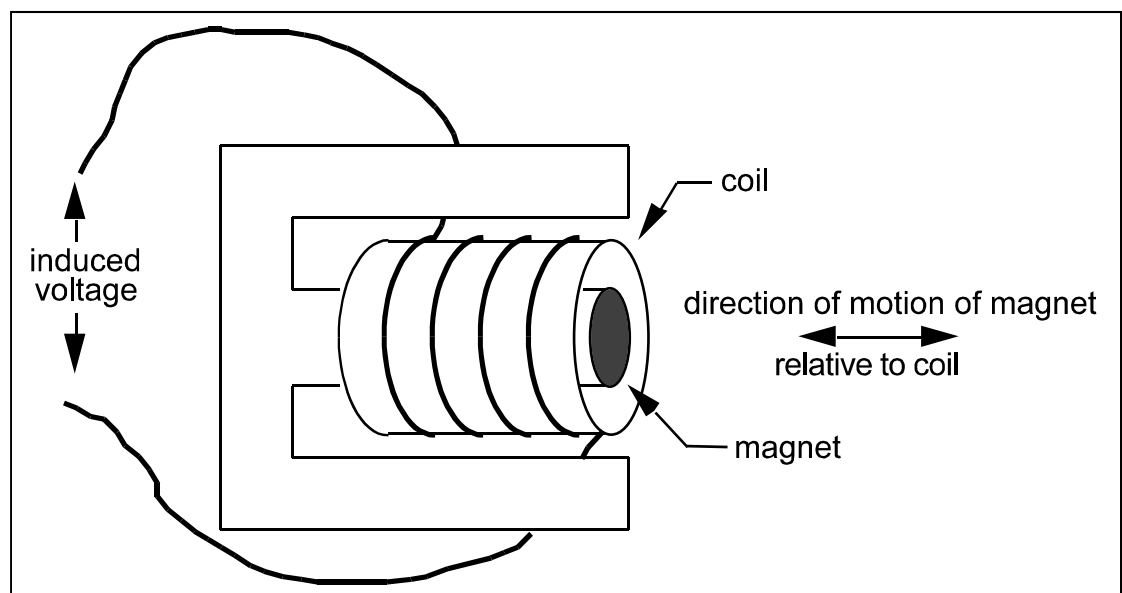

Figure 5.3 Geophone Sensor Operation.

Geophone sensor specifications give a number known as the Intrinsic Voltage Sensitivity. It is the coil voltage induced for a given coil versus magnet speed with units of V/in/s. In seismic applications, the magnet is moved by the blast energy because it is coupled to the particles of the

surrounding terrain. The coil, because of its inertia, does not move and the resulting magnet versus coil motion induces a voltage which is proportional to particle velocity.

### b. InstanTel Standard Transducer

InstanTel offers a 2 to 300 Hz standard transducer in a round package. The transducer may be installed on a floor, wall, or ceiling using a variety of installation procedures including ground spikes, burying, mounting rod, or optional leveling plate with leveling feet and integrated bubble level. The figure below includes an InstanTel Standard Transducer (a) and a Standard Transducer with leveling plate (b).

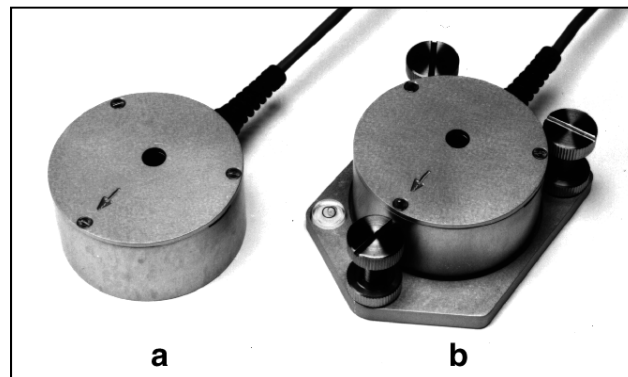

Figure 5.4 InstanTel Standard Transducer (a) and Standard Transducer with Optional Leveling Plate (b).

### c. Transducer Calibration Requirements

The geophone sensors inside InstanTel's transducers must be calibrated annually by InstanTel or an authorized InstanTel service facility. Contact your dealer for further information.

## 5.2.2. Microphone

The microphone measures air pressure. InstanTel offers two types, Linear "L" (standard) and "A" Weight (optional). Both come with a three foot (one meter) microphone mounting stand.

### a. Measurement Scales

The BlastMate III supports two sound pressure measurement scales: Linear "L" and "A" Weight.

#### (1) Linear "L"

Linear measurement is generally used to measure the effect of low frequency air pressure on buildings. The linear scale records sound pressure without modification in the 2 to 300 Hz range. Measurement units may be in absolute, Pascal, or relative dB scales.

#### (2) Weight

"A" Weight measures noise levels people may consider an annoyance. The signal is then converted to root mean square (RMS). Units are measured using the decibel scale, dB(A).

### b. Microphone Calibration Requirements

InstanTel's microphone must be calibrated annually by InstanTel or an authorized InstanTel service facility. Contact your dealer for further information.

## 5.3. Sensorcheck

Sensorcheck performs a two stage test on the BlastMate III and its sensors. In the first stage, the program displays the BlastMate III serial number, software version, the total amount of memory installed in the BlastMate III, the total amount of memory available to store events, and the number of events presently stored in memory. The second stage tests each geophone within Instantel's transducer and the microphone operation. The program also tests the operation of the BlastMate III itself and the sensor connecting cables. Pass or fail results appear on the display. See the Basic Reference chapter of this manual to choose when Sensorcheck operates automatically.

### 5.3.1. Checking the Transducer's Geophones

Sensorcheck measures a geophone's natural frequency and damping indicated by an Overswing Ratio (OR). Sensorcheck sends an electric pulse to the geophones and measures the response. If the geophone's response falls within a specified calibration range, the geophone is in calibration and monitoring operations can continue. If the geophone's response does not fall within a specified calibration range, the geophone is not calibrated. You cannot record events until you fix or replace the geophones. See the troubleshooting section of this manual for the appropriate procedures to follow.

#### a. Natural Frequency

Waveform measurements check the natural period (t) of a geophone's sensor coil assembly. Referring to the figure below, the distance from P<sub>1</sub> to P<sub>2</sub> represents 0.125 seconds. Since Frequency is the reciprocal of the period,  $F=1/t$ , the frequency is approximately 8 Hz. A calibrated sensor has a natural frequency between 6.5 and 9.5 Hertz. Calculations for all geophones appear with each recorded event.

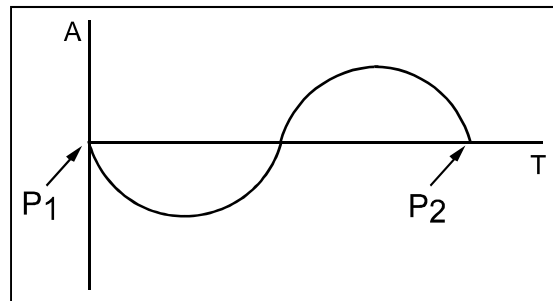

Figure 5.5 Calculating a Geophone's Natural Frequency.

#### b. Damping – Overswing Ratio (OR)

The overswing ratio (OR) measures damping and is calculated by computing the ratio of the magnitude of adjacent waveform peaks according to the following formula:

$$OR = \frac{A_1}{A_2}$$

Acceptable overswing ratios range from 2.8 to 4.8. The figure below displays a graph of a geophone coil's "free fall" response. A<sub>1</sub> and A<sub>2</sub> are used for overswing calculations.

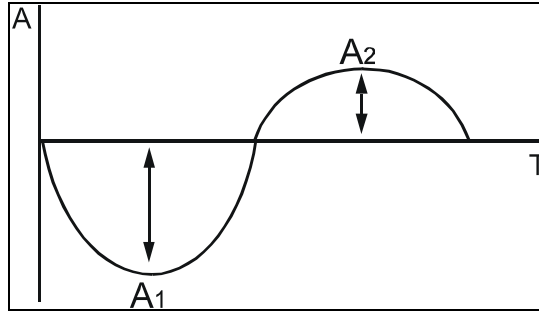

Figure 5.6 Calculating a Geophone's Overswing Ratio.

### 5.3.2. Checking the Microphone

Sensorcheck tests the microphone's operation by sending a signal to the microphone and measuring its frequency and amplitude response. If the results of the test fall within specified ranges, the microphone is within calibration.

### 5.3.3. Sensorcheck Report

The Sensorcheck report appears on the BlastMate III display. The message "All Channels Working, Press Print to Print" indicates the BlastMate III sensors have passed the Sensorcheck.

## 5.4. Anti-alias Filters

Aliasing occurs when a high-frequency signal appears as an erroneous low frequency because the waveform was sampled at too low a sampling rate. An anti-aliasing filter solves this problem by removing the high-frequencies.

## 5.5. Data Analysis Techniques

The following sections define the BlastMate III data analysis techniques. The first section, ground vibrations, discusses calculations applied to event data recorded by a transducer. The second section, sound pressure, describes the microphone event data calculations.

### 5.5.1. Ground Vibrations

The BlastMate III calculates the Peak Particle Velocity, Zero Crossing Frequency, Peak Acceleration, and Peak Displacement for each of the transverse, vertical, and longitudinal axes. The BlastMate III calculates Peak Vector Sum using data from all three axes.

#### a. Peak Particle Velocity (PPV)

Peak Particle Velocity indicates the maximum speed particles travel resulting from an event's ground vibrations. The BlastMate III calculates the PPV for each geophone.

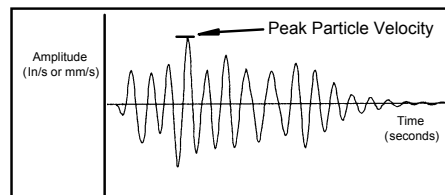

Figure 5.7 Calculating Peak Particle Velocity.



## b. Zero Crossing Frequency (ZC Freq)

The Zero Crossing Frequency calculates the event waveform's frequency at the largest peak.

### (1) Calculating Zero Crossing Frequency

To calculate the Zero Crossing Frequency, we need to determine the period of oscillation of the waveform. Convenient waveform positions for measuring period, the time for one complete cycle, occur between two successive peaks, troughs, or zero crossings. The BlastMate III measures between zero crossings. Frequency is the number of periods that occur in one second calculated by the formula: Frequency = 1/period.

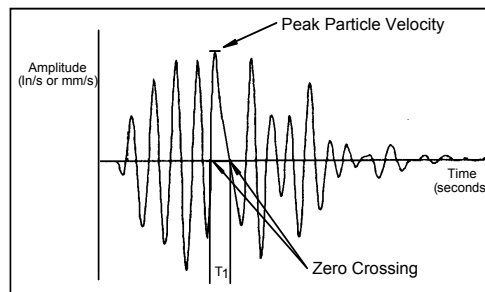

Figure 5.8 Calculating the Zero Crossing Frequency.

### (2) Zero Crossing Frequency Limitation

The Zero Crossing Frequency calculation is limited because it assumes a single predominant frequency at the peak, typically represented by sinusoidal waveforms. In practice, the peak may be the result of two or more major frequency components representing compound waveforms as illustrated in the figure below. It is therefore only an approximation of the frequency of the Peak Particle Velocity.

Waveforms may have the same Peak Particle Velocities but different Zero Crossing Frequencies depending on the shape of the waveforms involved. With reference to the figures above and below; both waveforms have the same Peak Particle Velocities however their Zero Crossing Frequencies differ. In the figure above, the zero crossing frequency uses the 1/2 period indicated by  $T_1$ . In the figure below, the zero crossing frequency uses the 1/2 period indicated by  $T_2$ . Notice that  $T_1$  is less than  $T_2$  because of the different waveform shapes, therefore the Zero Crossing Frequency in figure above is greater than the Zero Crossing Frequency in the figure below. It is for this reason, the Zero Crossing Frequency may differ for peaks having the same Peak Particle Velocity.

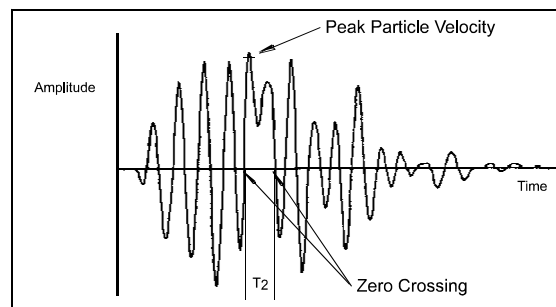

Figure 5.9 Zero Crossing Frequency Calculation Limitation.

### (3) Sample Rate Error

The Zero Crossing Frequency requires the period of a wavelength before it can calculate the wavelength's frequency using the formula  $1/\text{period}$ . A sampling error occurs for higher frequencies when wavelength periods become relatively small and the sampling rate begins to miss zero crossing points. In other words, the wavelength periods occur much faster than a BlastMate III can sample and use in the calculation.

At higher frequencies there are fewer sample points per cycle and therefore greater error. The following table illustrates how error increases with frequency.

Zero Crossing Frequency Sample Rate Error			
Frequency Range	Recording Rate		
	Standard (1024 Hz)	Fast (2048 Hz)	Faster (4096 Hz)
0 – 30 Hz	negligible error	negligible error	negligible error
31 – 50 Hz	up to 5 Hz error	up to 2.5 Hz error	negligible error
51 – 70 Hz	up to 8 Hz error	up to 4 Hz error	up to 2 Hz error
71 – 90 Hz	up to 18 Hz error	up to 9 Hz error	up to 4.5 Hz error
91 – 150 Hz	up to 50 Hz error	up to 25 Hz error	up to 12.5 Hz error

The BlastMate III does not calculate frequencies above 100 Hz because of the high error level at 1024 samples per second. The message ">100 Hz" displays. At 2048 samples per second, the message ">200 Hz" displays. When recording at 4096 samples per second, the message ">400 Hz" displays. Furthermore if a waveform is very complex, or if it contains a large offset value, the zero crossings may lie outside an acceptable window. Whenever a frequency cannot be calculated the message "<1 Hz" displays. The message N/A indicates an entire waveform was not captured and therefore no frequency could be calculated. More accurate analysis is available using the BlastWare III software.

### c. Peak Acceleration

The BlastMate III calculates peak acceleration, the rate of change of velocity, by dividing the difference in velocity by the difference in time. To obtain the peak acceleration, the BlastMate III subtracts two velocity readings and divides the result by the elapsed time between them.

$$a = \frac{dV}{dT} \approx \frac{\Delta V}{\Delta T}$$

where:

$\Delta t$  = a small interval

The BlastMate III calculates the peak acceleration at each point along the entire waveform and reports the peak value. Note that this is not necessarily at the peak velocity for an individual waveform.

#### d. Peak Displacement

The BlastMate III calculates peak displacement, or particle distance traveled, by multiplying speed by time. In the BlastMate III the interval velocity is multiplied by the time interval and the resulting displacement segments are summed.

$$s = \int V dt \approx \sum (V \Delta t)$$

where:

V = the velocity in each interval

To obtain the peak displacement, the BlastMate III integrates each wave segment of the entire waveform between zero crossings, selects the largest, then divides the value by half. Note that this is not necessarily at the peak velocity of the waveform.

#### e. Peak Vector Sum (PVS)

The figure below displays three event waveforms. The figure illustrates the procedure of graphically calculating peak vector sums. Measured magnitudes are tabulated for six different times and represent velocities in each of the three axes. The vector sum represents the resultant particle velocity magnitude and is calculated by squaring and adding the magnitudes and taking the square root.

$$PVS = \sqrt{T^2 + V^2 + L^2}$$

where:

T = particle velocity along the transverse plane

V = particle velocity along the vertical plane

L = particle velocity along the longitudinal plane

The BlastMate III calculates the peak vector sum for each point of the sampled waveforms and displays the largest value. Note that this is not necessarily at the peak velocity for an individual waveform.





EVENT WAVEFORMS			MAGNITUDE			PEAK VECTOR
TRANSVERSE	VERTICAL	LONGITUDINAL	T	V	L	
			-0.34	-0.33	0.14	0.494
			0.38	-0.47	0.38	0.714
			0.29	-0.31	0.51	0.663
			-0.53	0.23	-0.31	0.655
			0.24	0.07	0.36	0.440
			-0.23	-0.16	-0.15	0.318

Figure 5.10 Calculating the Peak Vector Sum.

### 5.5.2. Sound Pressure

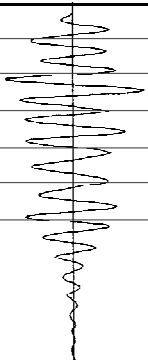
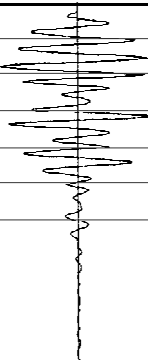
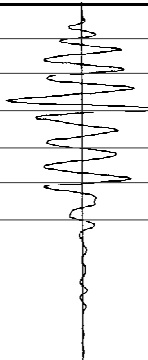
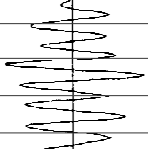
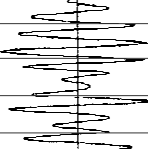
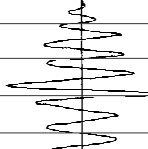
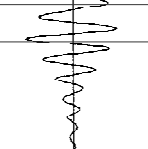
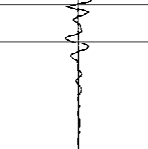
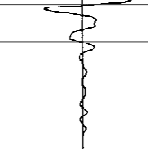
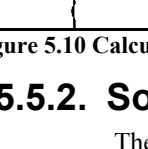
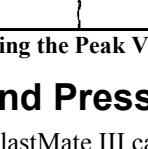
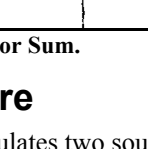
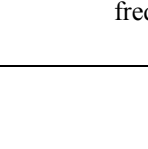
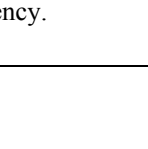
The BlastMate III calculates two sound pressure indicators, peak sound pressure and zero crossing frequency.

### a. Peak Sound Pressure (PSP)

The BlastMate III checks the entire event waveform and displays the largest sound pressure called the Peak Sound Pressure (PSP), also referred to as the Peak Air Over-Pressure. Results appear on the BlastMate III display and in the Event Summary Report.

### b. Zero Crossing Frequency (ZC Freq)

The Zero Crossing Frequency calculation for sound pressure is the same calculation used for ground vibrations. Please see above for a complete discussion.

**Note:** The Zero Crossing Frequency calculation is performed for Linear microphones only. This calculation does not appear on the BlastMate III display or on Event Summary Reports when using an “A” Weight microphone.

## 5.6. Alternate Manual Waveform Calculations

The following sections discuss manual waveform analysis techniques. These have been included for reference purposes only. They do not represent the calculation techniques employed by the BlastMate III.

Graphical methods for calculating area and slope depend on the shape of the waveform being analyzed. A complete discussion of the procedures is beyond the scope of this manual. Two useful reference texts are G. A. BOLLIGER, *BLAST VIBRATION ANALYSIS*, Southern Illinois University Press and CHARLES H. DOWDING, *BLAST VIBRATION MONITORING AND CONTROL*, Prentice-Hall Inc.

In each of the subsequent examples some formulae appear with no attempt at derivation. The following definitions apply:

A = amplitude in inches/second measured from the zero line

A<sub>m</sub> = amplitude measured in millimeters/second

T = period in seconds

Y = absolute change in amplitude over time measured in inches/second

Y<sub>m</sub> = absolute change in amplitude over time measured in millimeters/second

### 5.6.1. Sinusoidal Waveforms

The motion is essentially sinusoidal with gradual amplitude and frequency changes.

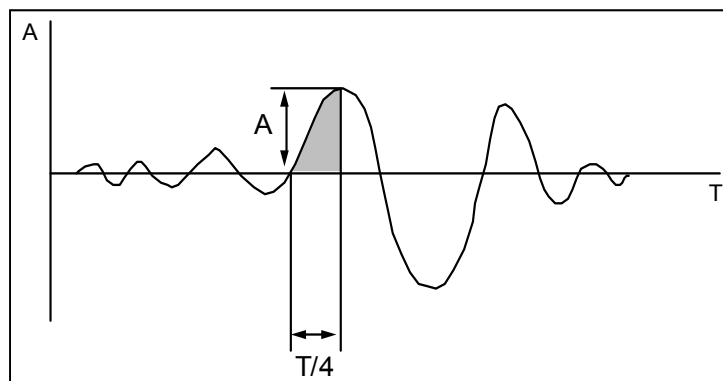

Figure 5.11 Manual Waveform Calculations on Sinusoidal Waveforms.

#### a. Calculating Displacement:

$$\text{Maximum Displacement (in.)} = \frac{T}{2\pi} \times A$$

$$\text{Maximum Displacement (mm)} = \frac{T}{2\pi} \times A_m$$

**b. Calculating Acceleration:**

$$\text{Maximum Acceleration (in./s}^2\text{)} = \frac{2\pi}{T} \times A$$

$$\text{Maximum Acceleration (mm/s}^2\text{)} = \frac{2\pi}{T} \times A_m$$

### 5.6.2. Nearly Triangular Waveforms

Motion is irregular and has large amplitude.

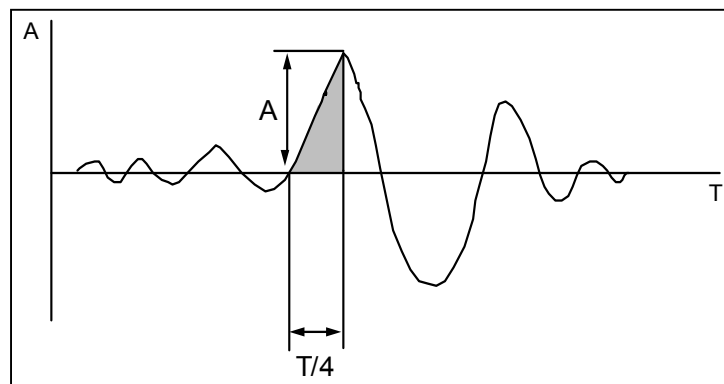

Figure 5.12 Manual Waveform Calculations on Nearly Triangular Waveforms.

**a. Calculating Displacement:**

$$\text{Maximum Displacement (in.)} = \frac{T}{8} \times A$$

$$\text{Maximum Displacement (mm)} = \frac{T}{8} \times A_m$$

**b. Calculating Acceleration:**

$$\text{Maximum Acceleration (in./s}^2\text{)} = \frac{1}{T} \times Y$$

$$\text{Maximum Acceleration (mm/s}^2\text{)} = \frac{1}{T} \times Y_m$$

### 5.6.3. Compound Waveforms

If the record exhibits interference by two or more predominant frequencies then the maximum displacement will be the sum of the maximum of each individual frequency component.

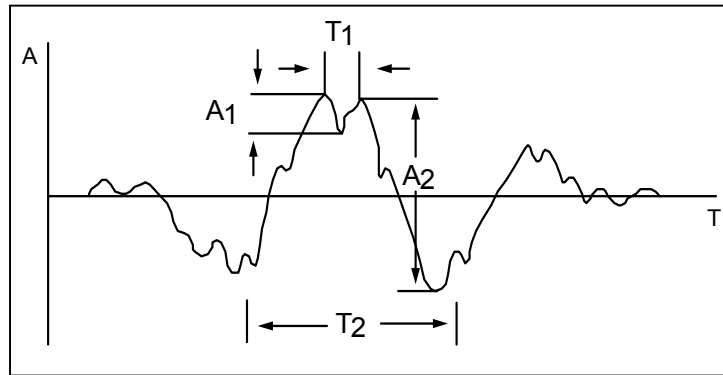

Figure 5.13 Manual Waveform Calculations on Compound Waveforms.

**a. Calculating Displacement:**

$$\text{Maximum Displacement (in.)} = \frac{T_1}{2\pi} \times A_1 + \frac{T_2}{2\pi} \times A_2$$

$$\text{Maximum Displacement (mm)} = \frac{T_1}{2\pi} \times A_{1m} + \frac{T_2}{2\pi} \times A_{2m}$$

**b. Calculating Acceleration:**

$$\text{Maximum Acceleration (in./s}^2\text{)} = \frac{2\pi}{T_1} \times A_1 + \frac{2\pi}{T_2} \times A_2$$

$$\text{Maximum Acceleration (mm/s}^2\text{)} = \frac{2\pi}{T_1} \times A_{1m} + \frac{2\pi}{T_2} \times A_{2m}$$

#### 5.6.4. Irregular Waveforms

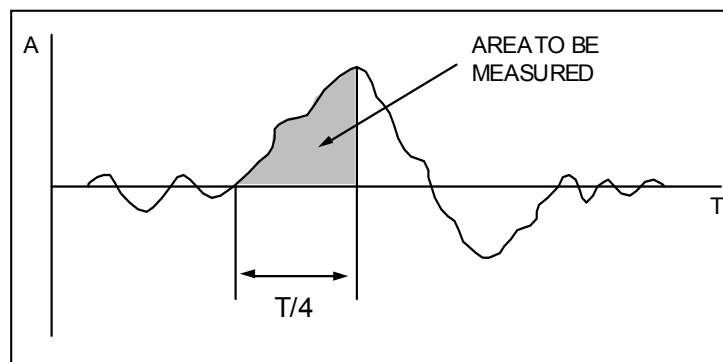

Figure 5.14 Manual Waveform Calculations on Irregular Waveforms.

**a. Calculating Displacement:**

Maximum Displacement = area under curve measured by a planimeter.

## 6. MAINTENANCE

This chapter outlines maintenance procedures for the BlastMate III including battery charging, annual sensor calibration, cleaning, loading paper into the printer, and paper handling precautions.

### 6.1. Battery Charging

The BlastMate III internal battery requires periodic and regular charging. To check the battery charge, turn the BlastMate III on and read the battery level from the Main Window. If a number appears in this window instead of the bars, charge the monitor immediately to avoid possible battery damage. Keep the unit on charge when not in use, or charge and then disconnect the battery if storing for prolonged periods of time.

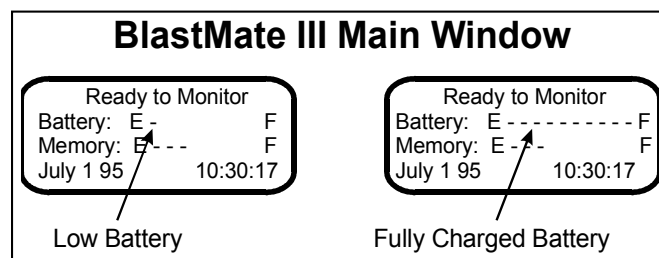

Figure 6.1 Battery Level Indicator.

**WARNING:** Open the monitor's lid to ensure adequate battery ventilation during charging. Always charge the monitor in a well ventilated area.

Do not allow the battery to become discharged and left in a discharged state for any extended period of time. Allowing the battery to become discharged may cause permanent damage to the battery.

To charge the battery, plug the AC adapter into the connector marked PWR located under the handle of the BlastMate III. Plug the other end into a 120 VAC 60 Hz electrical outlet. The battery charging indicator light turns on. For electrical outlets other than 120 VAC 60 Hz, you must use an optional power converter; see your dealer for more information.

All BlastMate III monitors use the DV-1250 AC adapter, provided with each monitor. The adapter restricts the voltage and current to no more than 12 VDC at 500 mA. Voltage can increase to 13.8 VDC without damaging the monitor. For example, an AC adapter with an output rating of 12 VDC at 1000 mA may be used as long as the voltage does not exceed 13.8 VDC for loads over 500 mA when used with a monitor. Check the manufacturer's specifications carefully to ensure the AC adapter does not exceed the maximum voltage and current specifications.

Use of AC adapters that exceed the maximum voltage and current specifications may cause undue stress on the monitor's internal regulators. Like all electronic devices, exceeding these specifications increases the risk of damage and possibly of an accidental fire. InstanTel's warranty does not cover this type of damage.

InstanTel recommends using the DV-1250 AC adapter supplied with each monitor. Replacements can be ordered from InstanTel. A 220 VAC adapter (p/n TC50A) is also available from InstanTel for use with the DV-1250 110 VAC adapter.

If required, other AC adapters may be used but must meet the following restrictive specifications.

Minimum Voltage Required by the Monitors	Maximum Output	Maximum No Load Voltage (VDC)	Maximum Power (VA)	Safety Rating (equal to)	Length of Cord	Plug Style and Size
11 VDC	less than 13.8 VDC for loads over 500 mA	18.8	12 maximum 6 recommended	CSA/UL	3 m (10 ft.)	2.1 mm Coaxial center post positive

## 6.2. Annual Calibration Requirements

Geophone sensors located inside the standard transducer and the microphone require annual calibration to ensure continued accurate monitoring results. Calibration may be performed by an authorized InstanTel service facility or by InstanTel. Contact your dealer to arrange to have your BlastMate III and its sensors calibrated.

## 6.3. Cleaning the BlastMate III

Vacuum dust, dirt, and sand from the BlastMate III. Use isopropyl alcohol to remove stains. Do not use paint thinners or ketone solvents. These may damage the BlastMate III. To avoid scratching the protective cover and display, do not scrub the surfaces with abrasive material including cleaning pads.

## 6.4. Loading Paper into the Printer

To load paper into the printer, turn the BlastMate III on and open the printer door. Remove the Paper Feed Roller, discard the old roll, and insert the new paper roll. Slide the Paper Feed Roller back into the slot in the printer compartment. Check that the paper rolls off the bottom of the roll. Fold the paper to create a point in the center of the paper end. This helps when feeding the paper into the printer and the Printer Takeup Roller. Release the Printer Roller by moving the Paper Load Lever to the upright position. Align the paper in the printer while drawing it out. Push the Paper Load Lever down to clamp onto the aligned paper. Feed the paper into the slot located on the Paper Takeup Roller and press the **Paper Takeup** key to advance the roller and take up the paper slack. You can also feed the paper through the printer door tear off slot. Feed the paper through the slot. Adjust the Tear Off Plate by loosening the two knobs, adjust the plate's position and tighten the knobs. Your BlastMate III is ready to print.

**Note:** You must center the paper coming from the printer roller to the Paper Takeup Roller. Failure to do so may cause the printer to jam during operation.



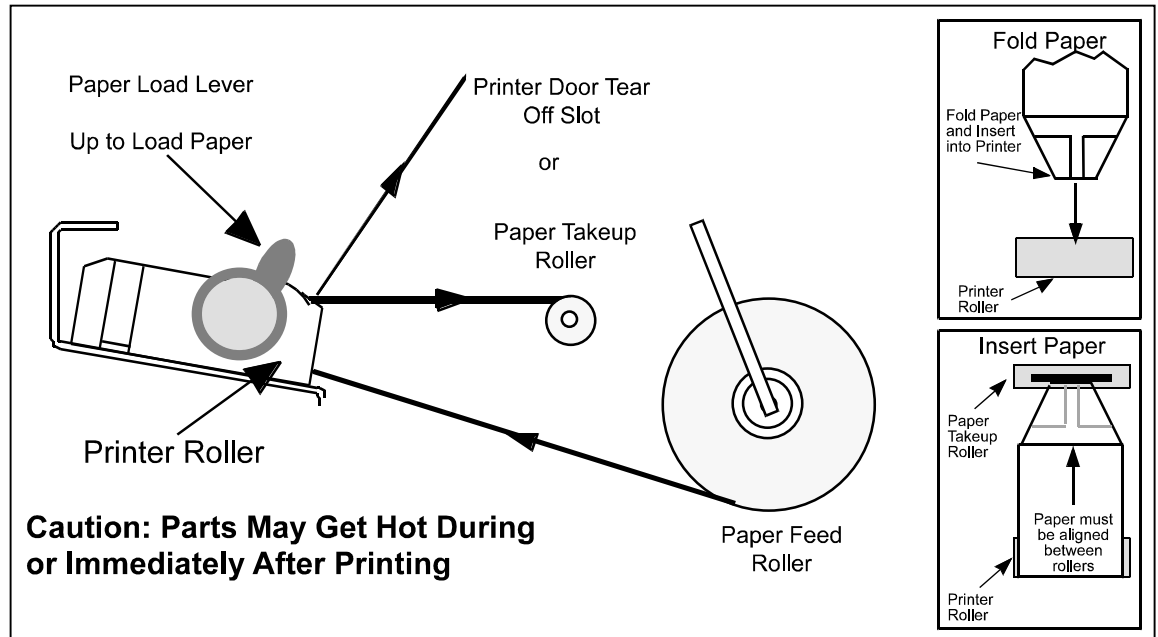

Figure 6.2 Loading Paper into the Printer.

For replacement paper, use Seiko TP-5000-80-25C or equivalent type paper. Contact Instanтел or one of the following suppliers:

**U.S. Distributor** – Sterling Electronics 800-745-5500

**Canadian Distributor** – Semad 800-387-0434

**Mexico, South and Central America** – Traderek International 909-861-0120

**Japan and Asian Countries** – Seiko Instruments Inc. Nami Maeda fax # 81 43 211 8035

**Germany/Europe** – Seiko Instruments GmbH. Jurgen Wiederspahn fax # 49 06 102 29722

## 6.5. Printer Handling Precautions

Please observe the following precautions, as recommended by the printer manufacturer, when handling the BlastMate III printer.

### 6.5.1. Printer

If any paper other than that specified is used, high print quality and long life of the thermal head cannot be guaranteed. Possible problems that may occur include poor print quality due to low-sensitivity paper, abrasion of the thermal head due to paper surface which is too rough, sticking between the thermal layer of the paper and the thermal head resulting in excessive noise during printing, print fading due to low print preservation, and a corroded thermal head.

Do not print without paper; otherwise, the platen or thermal head may become damaged.

Do not hit or scratch the surface of the thermal head with any sharp or hard object.

When the printer is not in use for long periods of time, place the thermal head in the up position. If the thermal head is left in contact with the platen, the platen may become deformed.

To prevent the heat elements, ICs, etc. from being damaged due to static electricity, take both antistatic and grounding measures before handling the printer.

Do not apply any stress to the flexible plastic connector (FPC) terminal.

Do not oil the mechanism. The oil attracts dirt particles causing printer malfunctions.

Clean dirt from the printer using a soft brush or compressed air.

### 6.5.2. Head Cleaning Procedure

To clean the printer head, follow the steps below.

1. Lift the head open lever (A) so it stands upright (B).
2. Push the head open lever into the opening in the back of the frame, rolling the head up (C), and latch it.
3. Clean the head elements using alcohol and a cotton swab. Use only ethyl or isopropyl alcohol. Do not use sandpaper, cutter, etc. when cleaning. They will damage the heat elements. Do not start the printing operation until after the alcohol is dry.
4. After cleaning, set the head open lever to its original position by reversing these steps.

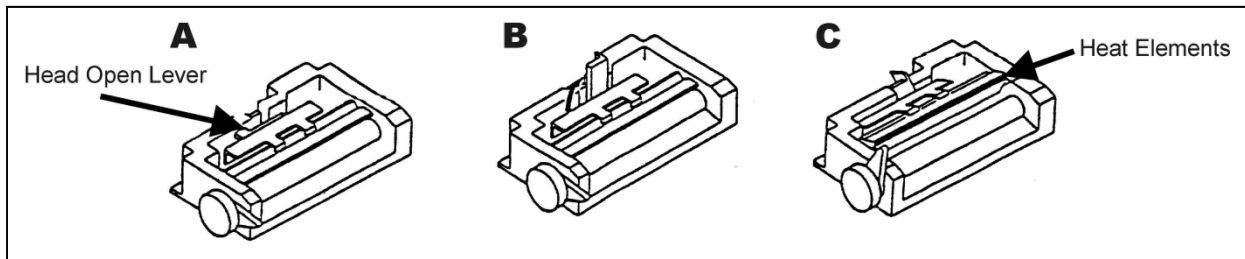

Figure 6.3 Cleaning the Printer Head.

## 6.6. Paper Handling Precautions

Please observe the following precautions, as recommended by the paper manufacturer, when handling the BlastMate III thermal paper.

### a. Avoid Hot and Humid Environment

#### (1) Storage Instructions

For long-term storage, store thermal paper in the dark at an average ambient temperature of less than 75 degrees fahrenheit (25 degrees celsius) and relative humidity of less than 65%. In this environment:

- Thermal paper will retain its printability for at least five years.
- If the paper is filed immediately after it has been printed, printed image remains legible for at least five years.

#### (2) Instructions on Use

Thermal paper begins to develop color at between 149 to 212 degrees fahrenheit (65 to 100 degrees celsius) and reaches applicable density at between 160 to 250 degrees fahrenheit (70 to 120 degrees celsius). However, the paper shows similar signs of development under high temperatures and/or humidity therefore, if the paper is to be used continuously at a temperature of 105 degrees fahrenheit (40 degrees celsius) for more than 24 hours, please pay attention to the ambient temperature and humidity.

### b. Avoid Exposure to Direct Sunlight

The paper will yellow if exposed to direct sunlight. Images tend to fade when left exposed to conventional fluorescent lighting for a long time. Exposure of printed paper should be avoided, for example, by filing soon after printing.

**c. Do Not Use Solvent Type Adhesives**

Adhesives containing volatile organic solvents such as alcohol, ester, ketone, etc., cause color formation and therefore, solvent type adhesives etc., should not be used. Starch, PVSA, and CMC-type adhesives are recommended.

**d. Avoid Contact with Plasticizers**

PVC film contains plasticizers such as ester phthalate. Prolonged contact with the PVC film reduces the image-formation ability of the paper and causes printed images to fade. Storage units made of polyethylene, polypropylene, polyester, etc. are recommended.

Be careful when using self-adhesive cellophane tapes which contain a plasticizer (alcohol-type). These can cause the printed image to fade. When attaching thermal paper to any other media, do not place tape on the coated side of the thermal paper. Double sided self-adhesive tape is recommended if applied on the non-coated side of the thermal paper.

Wax type thermal paper which contains plasticizer fades the images of thermal paper. Keep these two types of thermal paper separate when storing in files or cases.

**e. Others**

Avoid direct contact with freshly developed diazo copying. Color forming can occur on the surface of the thermal paper. Thermal paper sheets should be stored with their printed surfaces not touching to avoid transfer of one printed image to another. When the paper surface is scratched by a hard metal object, finger nail, etc., frictional heat causes images to develop. Please handle the paper with care. When the paper surface is sealed with a dirty or sweaty finger, the print image may fade slightly. Care should be taken when handling the paper.

**Notes:**

## 7. TROUBLESHOOTING

Use the following information to help solve operation problems.

FAULT	PROBABLE CAUSE	CORRECTIVE ACTION
The monitor does not turn ON.	No power source.	Verify 120 VAC is supplied. Check the fuse. Check the battery.
The monitor does not turn ON with battery only but does turn on using the AC Adapter.	Battery needs recharging.	Recharge the battery.
	Battery is dead.	Contact your authorized service facility.
The monitor sounds a “Beeping“ Indicator and a message appears on the display.	Battery needs recharging.	Recharge the battery.
	Battery is dead.	Contact your authorized service facility.
The monitor turns off unexpectedly.	Monitor has entered Power Saving Mode.	Press the <b>On/Off</b> key to activate the monitor.
	Battery needs recharging.	Recharge the battery.
	Blown Fuse	Replace the fuse (5 Amp, fast blow)
	Battery is dead.	Contact your authorized service facility.
The monitor fails to trigger and record an event.	The monitor is not in monitor mode.	Press the <b>Start Monitor</b> key to enter monitor mode.
	Trigger Level set too high.	Lower Trigger Level.
The monitor triggers continuously.	Trigger Level set too low.	Raise the Trigger Level.
	Noisy electric power supply.	Connect the monitor to a dedicated electric power supply line with no line noise or use a broadband noise filter.
The monitor does not record events.	The monitor’s memory is full.	Transfer events from the memory, verify the events transferred okay, then delete the events.
Warning Memory Less than 15%.	The monitor’s memory is almost full.	Transfer events from the memory, verify the events transferred okay, then delete the events.
Memory Full.	The monitor’s memory is full.	Transfer events from the memory, verify the events transferred okay, then delete the events.
Backlight does not turn ON.	Backlight on time set to zero.	Increase the backlight on time.
	Low Battery level.	Check the battery level and charge battery, as required.

FAULT	PROBABLE CAUSE	CORRECTIVE ACTION
Check Channel(s): Tran Message.	Transducer not connected.	Connect the transducer.
	The transducer not installed level.	Check the transducer installation for level.
	The transducer moved during Sensorcheck.	Press the <b>Test</b> key to run Sensorcheck again. Do not touch the transducer.
	Transducer cable improperly installed or damaged.	Check the cable connections and cables.
	Wall Installation – transverse and vertical geophones not switched.	Switch the transverse and vertical geophones.
	Damaged transducer.	Have the transducer checked by an authorized InstanTel service facility.
	Operating in Compliance Mode with a Series III sensor that does not support Sensorcheck.	In the monitor setups, set Sensorcheck to Disabled.
Check Channel(s): Vert Message.	Transducer not connected.	Connect the transducer.
	Transducer not installed level.	Check the transducer installation for level.
	Transducer moved during Sensorcheck.	Press the <b>Test</b> key to run Sensorcheck again. Do not touch the transducer.
	Transducer cable improperly installed or damaged.	Check the cable connections and cables.
	Transducer installed upside down.	Check the transducer for the arrow on the top.
	Ceiling Installation – Vertical geophone not inverted.	Invert the vertical geophone.
	Damaged transducer.	Have the transducer checked by an authorized InstanTel service facility.
	Operating in Compliance Mode with a Series III sensor that does not support Sensorcheck.	In the monitor setups, set Sensorcheck to Disabled.
Check Channel(s): Long Message.	Transducer not connected.	Connect the transducer.
	Transducer not installed level.	Check the transducer installation for level.
	Transducer moved during Sensorcheck.	Press the <b>Test</b> key to run Sensorcheck again. Do not touch the transducer.
	Transducer cable improperly installed or damaged.	Check the cable connections and cables.
	For wall installations, the arrow was not pointed towards the event.	Point the arrow located on the top of the standard transducer towards the event.
	Damaged transducer.	Have the transducer checked by an authorized InstanTel service facility.
	Operating in Compliance Mode with a Series III sensor that does not support Sensorcheck.	In the monitor setups, set Sensorcheck to Disabled.
Check Microphone Message.	Microphone not connected.	Connect the microphone.
	Damaged microphone or microphone cable.	Have the microphone checked by an authorized InstanTel service facility.

# Appendix





## a) Parts and Accessories

DESCRIPTION	PART NUMBER
<b>Transducers</b>	
Round Standard Transducer, 2 to 300 Hz	714A0301
Series III Standard Uniaxial Geophone	Vertical – 714A4201 Horizontal – 714A4202
Uniaxial 4.5 Hz Geophone	Vertical – 714A4601 Horizontal – 714A4602
Low Level Triaxial Geophone	100x gain – 714A8301 10x gain – 714A8302
Series III High Frequency Uniaxial Geophone	714A4101
Bore Hole Transducer	714A3301
Hydrophone Sensor	714A5001
VOD Module	714A7201
Low Frequency Accelerometer, 0.5 g range: requires other accessories, contact your dealer or InstanTel	714A7101
High Frequency Accelerometer, 500 g range: requires other accessories, contact your dealer or InstanTel	338B34
Transducer Leveling Plate with leveling feet and integrated level	714A1801
<b>Microphones</b>	
Microphone – Linear “L” Output	714A0401
Microphone – “A” Weight Output (Impulse Response – 35 milliseconds)	714A2001
High Pressure Microphone: for measuring pressure up to 5.0 psi (34.5 kPa)	714A5501
Microphone Windscreen	1712
Microphone Stand Assembly	714A3401
<b>Event Memory</b>	
Extra 1200 Event Capacity (installed)	714A2201
<b>AC Adapter</b>	
120 VAC, 60 Hz Adapter(output 12 VDC 500 mA)	DV – 1250
220 VAC, 50 Hz Adapter (used with the DV–1250)	TC50A
External 12 V Battery Power Supply Cable	714A2401
<b>Extension Cables</b>	
Extension Cable Line Driver 100 ft. (30 m) for triaxial transducer	714A7601
Extension Cable Line Driver 250 ft. (75 m) for triaxial transducer	714A7602
Quad Splitter Cable	714A3201
Triax & Uniax Splitter Cable: for use with 8 channel units standard transducer and microphone	714A3901
<b>Accessories</b>	
MiniMate Plus to BlastMate III Cable: RS–232 cable for programming MiniMate Plus from BlastMate III	716A1801
BlastMate III replacement Printer Paper Roll (Package of 10)	TP5000–80–25C
Remote Alarm	711A1401
DS 20 Wire Trigger	677A9601
BlastMate Trigger Cable	712A3901
Null Modem Cable for connecting between unit and modem	714A7501
Accessory case with rigid foam insert. Same as BlastMate case. Can also carry 1–2 MiniMate Plus units	714A2601

## b) Series III Specifications

Seismic	Range	10 in/s (254 mm/s).
	Resolution	0.005 in/s (0.127 mm/s), to 0.000625 in/s (0.0159 mm/s) with built-in preamp.
	Trigger Levels	0.005 to 10 in/s (0.127 to 254 mm/s) in steps of 0.001 in/s (0.01 mm).
	Frequency Analysis	National and Local Standards for all countries (see text).
	Accuracy	3% at 15 Hz.
	Acceleration, Displacement	Calculated using entire waveform, not estimated at peak.
Air Linear	Range	88–148 dB, $7.25 \times 10^{-5}$ psi to 0.0725 psi, 0.5 Pa to 500 Pa.
	Resolution	0.1 dB above 120 dB (0.25 Pa).
	Trigger Levels	100–148 dB in 1 dB steps.
	Accuracy	0.2 dB at 30 Hertz and 127 dB.
“A” Weight (optional)	Range	50 to 110 dB in steps of 0.1 dB. (Impulse Response – 35 milliseconds)
Sampling Rate		Standard 1024 samples per second per channel to 16,384 (8,192 for 8 channel).
Event Storage	Full Waveform Events	300 standard and 1500 optional at standard sample rate of 1024.
	Summary Events	1750 standard and 8750 optional at standard sample rates of 1024.
Frequency Response	2 to 300 Hz	Ground and Air, Independent of record time.
Full Waveform Recording	Fixed Record Modes	Manual, single shot, continuous and programmed start/stop.
	Fixed Record Time	1 to 100, 300 or 500 sec plus 0.25 sec pre-trigger.
	Auto Record Mode	1 to 100, 300 or 500 sec plus 0.25 sec pre-trigger.
Strip Chart Recording	Record Method	Record to memory and/or internal printer. Program interval 2, 5, 15, 60, 300 or 900 sec.
	Days Storage	2.8 or 14 days at 5 second interval. 34 or 170 days at 60 second interval.
Histogram Combo Mode	Histogram Record Method	Record to memory and/or internal printer. Program interval 2, 5, 15, 60, 300 or 900 sec.
	Histogram Days Storage	2.4 or 12 days at 5 second interval. 29 or 147 days at 60 second interval.
	Waveform Events	Up to 13 one-second events (1024 sample rate, four channels recording).
	Waveform Record Times	1 to 13 seconds plus 0.25 sec pre-trigger.
Special Functions	Timer Operation	Programmed start/stop.
	Self Check	Programmable daily check.
	Scaled Distance	Weight and distance stored with event.
	Monitor Log	History printout programmable up to all events stored.
	Automatic download	Automatic downloading of data from a unattended monitor with Auto Call Home.
	Measurement Units	Imperial or metric, dB or linear air pressure, or in units of custom sensors.
Printer	Resolution	576 dots/line and 0.0049 inches (0.125 mm) per dot.
	Print Time	Less than 10 seconds for typical 1 second event with full analysis.
	Paper Control	Paper tear slot or automatic paper takeup, separate keys for feed and takeup.
	Rated Life – print head	18 miles (30 km) of printing.
	Number of Copies	1 to 10 copies automatic, any number manual.
User interface	Keyboard	64 domed tactile with separate keys for common functions.
	Display	4 line by 20 character high contrast backlit display with on line help.
Battery Life		30 days continuous recording, 70 days with timer, printing will decrease life.
Fuse		5 A/250 V part number F5AH250V only

## Series III Specifications (continued)

Dimensions		10.6" x 14.0" x 6.5" (269 mm x 355 mm x 165 mm).
Weight		14 lbs. (6.4 kg).
Warranty	2 Years Parts and Labor	Calibration and equipment check required at 1 year to maintain warranty.
Environmental	Printer/ LCD	14 to 122 degrees F (-10 to 50 degrees C) operating.
	Electronics	-4 to 131 degrees F (-20 to 55 degrees C) operating.
	Humidity	5 - 90% RH non - condensing
	Storage	-4 to 160 degrees F (-20 to 70 degrees C).

InstanTel reserves the right to change specifications without notice.

### c) Compliance Reports

The BlastMate III supports numerous Compliance Reports, also called National Frequency Analysis Standards, including U.S.A. USBM/OSMRE, British Standard BS 6472, French GFEE, German DIN 4150, New Zealand 4403:1976, and Spain UNE 22.381. Two frequency standards, U.S.A. USBM/OSMRE and German DIN 4150, appear below. Use the BlastWare III software to choose the Compliance Report used by your monitor.

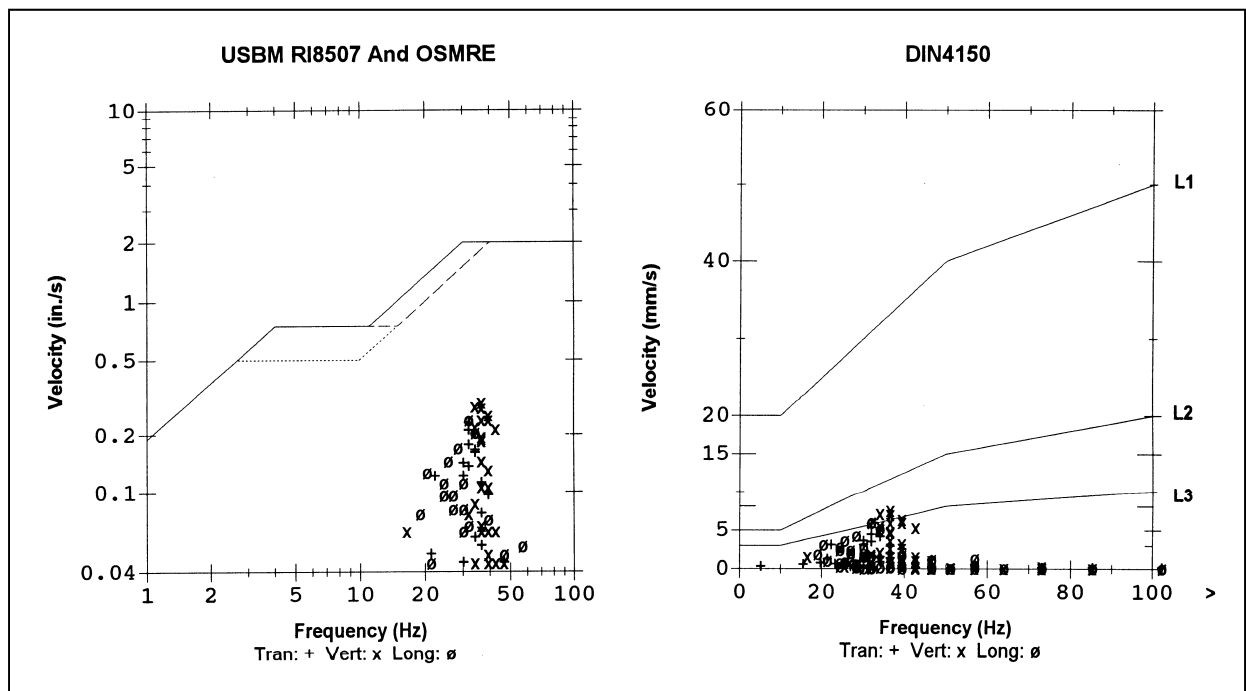

Figure A-1 United States Bureau of Mines and German DIN 4150 Compliance Reports.

**Note:** Data points appearing outside of the report boundaries indicates the recorded data was outside the range of the report. In the DIN 4150 example, some peaks occurred at frequencies greater than 100 Hz and were therefore drawn outside the boundaries of the report.

Using the optional BlastWare III Advanced Module, you can edit Compliance Reports or create an entirely new report to meet your specific needs.

## d) Calculating Battery Life

The BlastMate III battery life depends on current draw, battery longevity, and ambient temperature.

### Battery Life versus Current Draw

Battery life depends on battery capacity and current draw. Battery capacity is stated in ampere hours and is the product of discharge current and discharge time. With a fully charged battery, the BlastMate III has a battery life of 30 days in continuous monitor mode. If you use the Timer for eight hour daily monitoring, the battery life increases to approximately 70 days in monitor mode. An optional extra battery can be installed in the monitor to almost double battery life.

**Note:** Histogram record mode consumes more battery power than the other recording modes. We recommend connecting a monitor to the AC adapter or an external power supply.

### Aggregate Sample Rate

The aggregate sample rate (sample rate x the number of recording channels) measures the effect of choosing combinations of sample rates and recording channels. The following table lists the approximate battery life at various aggregate sample rates. The first section applies to the continuous record mode. The second section applies to the histogram record mode.

Battery Life		
Aggregate Sample Rate	BlastMate III 4 Channel	BlastMate III 8 Channel
65536	6.9 days	6.2 days
32768	11.7 days	10.2 days
16384	17.7 days	14.4 days
8192	24.3 days	18.3 days
4096	30.0 days	21.3 days
2048	33.6 days	23.1 days
1024	35.4 days	24.6 days
512	36.2 days	27.9 days
Histogram Interval	BlastMate III 4 Channel	BlastMate III 8 Channel
2 seconds	3.43 days	2.73 days
5 seconds	3.56 days	2.75 days
15 seconds	3.69 days	2.77 days
1 minute	3.84 days	2.78 days
5 minutes	3.84 days	2.78 days
15 minutes	3.84 days	2.78 days

Note: sufficient memory capacity must be available.

## Battery Longevity

Battery longevity refers to a battery's useful service life determined by the number and depth of discharge cycles. The following indicates the expected battery longevity expressed in charge/discharge cycles. A battery lasts longer if it is kept in a charged condition.

<b>Depth of Discharge</b> (Capacity)	<b>Longevity</b> (Charge/Discharge Cycles)
100 %	200
50 %	400
30 %	1200

## Battery Capacity Varies with Ambient Temperature

Battery capacity is a function of ambient temperature and rate of discharge. At 68°F (20°C) the rated capacity is 100%. The capacity increases above this temperature and decreases below this temperature.

**Notes:**

# Index

## A

- A Weight
  - and zero crossing frequency, 5–12
  - in event monitoring, 3–1
  - measurement scale, 5–6
  - microphone type, 3–15
  - microphone units, 3–16
- Accessories, 1–3
- Adapter
  - charging the battery, vi
  - voltage, vi
- Advanced Channels, 4–4
- Advanced Module, 4–1
- Alarm Level
  - geophone, 3–16
  - microphone, 3–16
- Analysis Techniques, 5–8
- Anti-alias Filters, 5–8
- Arrow Keys, 3–23
- Auto Call Home, 3–17
  - testing, 3–17
- Auto Record
  - definition of, 3–9
  - record time key, 3–9
- Auto Window, 3–18
  - and Auto Record, 3–9
  - range, 3–18
- Auxiliary Trigger, 3–19

## B

- Back Light Key, 3–28
- Backlight On Time, 3–19
- Basic Channels (Compliance Module)
  - geo channels, 3–15
  - mic channel, 3–15
- Battery
  - aggregate sample rate, A-6
  - battery life versus current draw, A-6
  - calculating battery life, A-6
  - capacity varies with ambient temperature, A-7
  - charging, vi, 6–1
  - extending life using the timer, 3–13
  - longevity, A-7
  - monitoring LCD cycle to conserve battery power, 3–20
  - power saving timeout to conserve battery power, 3–19
  - turn back light off to conserve power, 3–19
- Baudrate, 3–17

- Beep When Triggered, 3–18
- Bolting the Standard Transducer, 3–4
- Burying the Standard Transducer, 3–3

## C

- Calibration
  - annual calibration requirements, 6–2
  - maintaining warranty. *See* the title page
  - transducer calibration requirements, 5–6
- Call Home, 3–17
- Call Home Test, 3–17
- Cancel Key, 3–23
  - exit all monitor modes, 3–23
  - press to display the main window, 3–6
  - press to stop printing, 3–25
- Ceiling Installation, Standard Transducer, 5–3
- Channel Range, advanced module, 4–2
- Charge Weight, 3–21
- Cleaning the BlastMate III, 6–2
- Compliance Module, 3–1
- Compliance Report (Compliance Module Only), 3–13
- Compliance Reports, A-5
- Compound Waveforms, 5–13
- Condensed Instructions, viii
- Continuous Record Mode, 3–7
- Conventions Used throughout this Manual, viii
- Customer Support. *See* the title page
- Cut Cable Detection, 3–20

## D

- Daily Self Check (Compliance Module Only), 3–14
- Damping, 5–7
- Data Analysis Techniques, 5–8
- Date
  - displayed in the start up window, 2–1
  - setting, 3–22
- Delete All Events, 3–24
- Direct Baudrate or Modem Baudrate, 3–17
- Distance from blast, 3–21

## E

- EC Warning. *See* the title page
- Edit Keys, 3–22
- Eight Channel Models, 3–2
- Electric Power Supply, v
- Enter \* Key, 3–22
- Event List, printing, 3–25

Event Monitoring, 3–1

Events

- delete all events, 3–24
- print all events, 3–25
- print event list, 3–25
- print last event, 3–25
- print selected event, 3–25
- recording events, see the basic tutorial, 2–1
- view events, 3–23

Events Keys, 3–23

Extended Notes, 3–21

Extended Notes Title, 3–21

Extension Cables, part numbers, A-3

## F

Factory Defaults, resetting, 3–18

False Events

- manual record mode, 3–7
- using the timer to minimize, 3–13

Features and Benefits, 1–2

Fixed Record Time, 3–9

Fuse installation. *See* the package contents that came with the monitor

Fuse replacement, vi

## G

Geo Alarm Level (Compliance Module Only), 3–16

Geo Channels, 3–15

Geo Range (Compliance Module Only), 3–8

Geo Trigger Level, 3–11

Geophone

- geo channels, 3–15
- geo trigger level, 3–11
- operation, 5–5
- range, 3–8
- trigger source, 3–11
- type (Compliance Module Only), 3–16

Geophone and Microphone, as trigger source, 3–11

Geophone Type (Compliance Module Only), 3–16

Ground Spikes, 3–3

Ground Vibrations

- analysis techniques, 5–8
- as trigger source, 3–11
- measured by the transducer, 5–8
- types, 3–1

## H

Handling Precautions

- general, vii
- paper, 6–4
- printer, 6–3

Hard Surface Installations, Standard Transducer, 3–4

Help Key, 3–22

Histogram

    histogram interval, 3–10

    histogram printout, 3–12

Histogram (Strip chart) Record Mode, 3–7

Histogram combo Record Mode, 3–7

Histogram interval, 3–10

## I

Identification Numbers, v

Imperial, 3–15

Installation

- bolting, 3–4
- burying, 3–3
- ceiling, 5–3
- ground spikes, 3–3
- leveling plate, 3–4
- sandbagging, 3–5
- wall, 5–1

Installation, Standard Transducer, 3–2

Installing the Standard Transducer Using the Leveling Plate, 5–4

InstanTel Standard Transducer, 5–5

Instructions, condensed, viii

Instrument Mode, 4–1

Irregular Waveforms, 5–14

## J

Job Number Format, 3–21

## K

Keyboard

- BlastMate III keys, 1–4
- description of, 3–5

Keyboard Keys, 3–28

## L

Linear L microphone

- measurement scale, 5–6
- microphone type, 3–15
- microphone units, 3–16
- part number, A-3
- specifications, A-4
- theory of operation, 5–6

List Events, see view events, 3–23

List/Delete Key, 3–23

Longitudinal Axis, 3–1



**M**

Maintenance, 6–1  
Manual Record Mode, 3–7  
Manual Waveform Calculations, 5–12  
Maximum Geo Range (Compliance Module Only), 3–8  
Maximum Record Times, 4–3  
Measurement Scales, 5–6  
Measurement System (Compliance Module Only), 3–15  
Memory  
    checking amount available, vi  
    checking amount installed, 3–6  
    delete events, 3–24  
    saving, 3–15  
Memory capacity – histogram record mode, 3–10  
Metric, 3–15  
Mic Alarm Level (Compliance Module Only), 3–16  
Mic Channel, 3–15  
Mic Trigger Level, 3–11  
Microphone  
    A Weight, 5–6  
    extension cable, 1–3  
    installation, 3–5  
    Linear L, 5–6  
    mic alarm Level, 3–16  
    mic channel, 3–15  
    mic trigger level, 3–11  
    microphone type, 3–15  
    microphone units, 3–16  
    operation, 5–6  
    part numbers, A-3  
    sensorcheck plot, 3–13  
    serial number, v  
    testing, 3–5  
    trigger source, 3–11  
    windscreen, A-3  
Microphone Calibration Requirements, 5–6  
Microphone Type (Compliance Module Only), 3–15  
Microphone Units (Compliance Module Only), 3–16  
Models, 1–1  
Modem  
    serial connection, 3–17  
    setting the baudrate, 3–17  
Monitor Everyday, 3–14  
Monitor Log, 3–26  
Monitor Once Only, 3–13  
Monitoring LCD Cycle, 3–20

**N**

Natural Frequency, 5–7  
Notes Key, 3–21  
Number of Copies, for printed events, 3–12

**O**

On/Off Key, 3–6  
Option Key, 3–18  
Option Key + Special Key  
    advanced module, 4–1  
    compliance module, 3–18  
    Instrument Mode, 4–1  
Option Key + Time/Day Key, 3–20  
Overswing Ratio, 5–7

**P**

Paper  
    handling precautions, 6–4  
    loading paper into the printer, 6–2  
    replacement paper, 6–3  
Paper Feed Key, 3–27  
Paper Takeup Key, 3–27  
Part Numbers, 3  
Parts and Accessories, 3  
Password, 3–19  
Peak Acceleration, 5–10  
Peak Displacement, 5–10  
Peak Particle Velocity (PPV), 5–8  
Peak Sound Pressure (PSP), 5–11  
Peak Vector Sum (PVS), 5–11  
Power Saving Timeout, 3–19  
Precautions  
    general, vii  
    paper handling, 6–4  
    printer, 6–3  
Print  
    all events, 3–25  
    event list, 3–25  
    last event, 3–25  
    monitor log, 3–26  
    selected event, 3–25  
Print Events, 3–11  
Print Key, 3–25  
Printer  
    head cleaning procedure, 6–4  
    loading paper, 6–2  
    paper handling precautions, 6–4  
    printer handling precautions, 6–3  
    replacement paper, 6–3  
Printer Keys, 3–27  
Program Keys, 3–7

**R**

Range, geophone, 3–8  
Record Mode, 3–7  
    continuous record mode, 3–7  
    histogram (strip chart) record mode, 3–7

- histogram combo record mode, 3–7
- manual record mode, 3–7
- single shot record mode, 3–7
- Record Mode Key
  - advanced module, 4–2
  - compliance module, 3–7
- Record Stop Mode, 3–9
  - auto, 3–9
  - fixed, 3–9
- Record Time Key
  - advanced module, 4–3
  - compliance module, 3–9
- Record Time, setting, 3–10
- Record Times, maximum, 4–3
- Recording Time, increasing, 3–10
- Reference, 5–1
- Registration Card, vii
- Remote Alarm
  - geo alarm level, 3–16
  - mic alarm level, 3–16
- Reset Factory Defaults, 3–18
- Review Setups Key (Compliance Module Only), 3–6
- Run Keys, 3–6

**S**

- Sample Rate
  - advanced module, 4–2
  - compliance module, 3–8
- Sample Rate Availability, 4–2
- Sample Rate Error, in zero crossing frequency, 5–9
- Sandbagging, installing the standard transducer, 3–5
- Scaled Distance, 3–21
- Sensorcheck (Compliance Module Only)
  - automatic setting, 3–14
  - printing, 3–13
  - sensorcheck report, 5–8
  - test key, 3–6
  - theory of operation, 5–6
- Serial Connection, 3–17
- Setup Printout, 3–12
- Setups Printer Key, 3–11
- Setups Special Key
  - advanced module, 4–4
  - compliance module, 3–13
- Single Shot Record Mode, 3–7
- Sinusoidal Waveforms, 5–12
- Soft Surface Installations, Standard Transducer, 3–3
- Software Version, installed in the monitor, 2–1
- Sound Pressure, 5–11
  - analysis, 5–11
  - peak sound pressure (PSP), 5–11
  - zero crossing frequency (ZC Freq), 5–11
- Specifications, A-4

- Standard Transducer. *See* transducer
- Start Monitor Key, 3–6
- Storage Mode, 3–8
- Strip Chart, *see* Histogram Record Mode, 3–7

**T**

- Test Key
  - advanced module, 4–1
  - compliance module, 3–6
- Theory of Operation, Standard Transducer, 5–4
- Time
  - displayed in the Main Window, 2–1
  - setting, 3–22
- Time/Day Key, 3–22
- Timer Mode, 3–13
- Transducer
  - bolting, 3–4
  - burying, 3–3
  - calibration, 5–6
  - ceiling installation, 5–3
  - extension cable, 1–3
  - geo alarm level, 3–16
  - ground spikes, 3–3
  - hard surface installations, 3–4
  - installation, 3–2
  - leveling plate, 1–3
  - part numbers, A-3
  - sandbagging, 3–5
  - soft surface installations, 3–3
  - theory of operation, 5–4
  - trigger level, 3–11
  - trigger source, 3–11
  - wall installation, 5–1
- Transverse Axis, 3–1
- Triangular Waveforms, 5–13
- Trigger Level Key
  - advanced module, 4–4
  - compliance module, 3–11
- Trigger Sample Width, 3–20
- Trigger Source Key
  - advanced module, 4–3
  - compliance module, 3–11
- Troubleshooting, 7–1
- Tutorial, 2–1

**V**

- Vertical Axis, 3–1
- View Events, 3–23

**W**

- Wall Installation, Standard Transducer, 5–1



Warning Alarm

geo alarm level, 3–16

mic alarm level, 3–16

Warranty. *See* the title page

Waveform Calculations, *see* Data Analysis Techniques,  
5–8

Waveform Plot, 3–12

Website. *See* the title page

**Z**

Zero Crossing Frequency (ZC Freq), 5–8

calculating, 5–8

limitation, 5–9

not calculated for A Weight microphone, 5–12

sample rate error, 5–9

sound pressure, 5–11

**Notes:**